

# The Taverners

by

John P. Taverner

Volume II

VOLUME 2

Dear Reader,

Volume 1 of The Taverners presented an amazing amount of information in shorthand form. Its object, to put down as much information as possible to help any other researcher.

Already, during the preparation of Volume 1 more information has become available.

Volume 2 contains chapters about the origins of the name, the Taverner Coat of Arms, and Taverners County-by-County.

John P. Tavener  
238 Hesketh Lane  
Tarleton  
Lancashire  
ENGLAND  
1995.

## INDEX VOLUME 2

- Chapter 1. Did the Taverners fight with William at the Battle of Hastings in 1066.
2. Origins of the Name
  3. The Taverner Coat of Arms.
  4. The Taverners, County by County.
  5. The Taverners of Middlesex and London.

OTHER VOLUMES - EXISTING OR IN PREPARATION:-

THE TAVERNERS		VOLUME 1	A MISCELLANY
THE TAVERNERS	£ 5.50	VOLUME 2	A MISCELLANY
THE TAVERNERS OF HULL	£ 5.50		VOLUME 3
WILLIAM TAVERNER JR, ARTIST 1700-1772	£ 25		VOLUME 4
THE TAVERNERS OF IRELAND	£ 5.50		VOLUME 5
THE TAVERNERS OF AMERICA	£ 5.50		VOLUME 6
THE TAVERNER DIARIES 1200-1299			VOLUME 7
THE TAVERNER DIARIES 1300-1399			VOLUME 8
THE TAVERNER DIARIES 1400-1499			VOLUME 9
THE TAVERNER DIARIES 1500-1599			VOLUME 10
THE TAVERNER DIARIES 1600-1699			VOLUME 11
THE TAVERNER DIARIES 1700-1799			VOLUME 12
THE TAVERNER DIARIES 1800-1899			VOLUME 13
THE TAVERNER DIARIES 1900 -			VOLUME 14
THE PROPERTY OW <sup>N</sup> ING TAVERNERS OF ESSEX			VOLUME 15
CHAUCER'S GRANDFATHER WAS A TAVERNER			VOLUME 16
WILLIAM TAVERNER SR PLAYWRIGHT.			VOLUME 17
TAVERNER WILLS			284
THE ROAD TO SAMUEL TAVERNER'S GARDEN	£ 5.50		18

## CHAPTER 1

Did the Taverners fight with William the Conqueror in 1066?

Mostly family researchers try to trace their ancestors back to the battle of Hastings.

Some recent research has shown that very few if any family can claim for certain to have been with William.

The Battle Abbey Roll is a list of people supposed to have fought with William. The original has been lost, but it was probably a fourteenth century production. A number of copies exist, all unfortunately different.

In his excellent book "My Ancestors came over with the Conqueror" by A.J. Camp, published by the Society of Genealogists, Anthony Camp list giving references - all the names in the Battle Abbey Roll copies, and writes in heavy type those names almost certainly proven to be at the battle.

We find "TAVERNER (ref 1&3) Tauerner Cleveland III 192".

### REFERENCES

1. = The Battle Abbey Roll as published by Raphael Holinshed in his "Chronicles of England, Scotland and Ireland" (1517).

3. = The Battle Abbey Roll as published by Andre Duchesne in his "Historiae Normannorum" (1619).

Cleveland = The Duchess of Cleveland's The Battle Abbey Roll 3 Vols (1889).

## CHAPTER 2

### TAVERNER. ORIGINAL MEANING OF THE NAME.

(This piece supplied by a distant Irish relative).

On the face of it the origin is Latin: Tabula = a board. Taverns = a shed, tent or booth. In Roman times there was a tribe called Tabernae inheriting what is now Flanders or N. France. In time the "b" came to be softened to "v". Bearers of the name from being dwellers in tents came to signify inn keepers.

SPELLING:- The continental form is generally Tavernier. The English has many variants. The earliest form taken from official documents is le Taverner (see genealogical tree of Norfolk & Hertfordshire). State documents shown an occasional Tavernor. Church registers in Lancashire (Bolton & Wigan) shown the Taverner form, and about Nuneaton Tabberer. I have seen it also in the form Tafner, Taviner. Possibly Verner is a variant. Sir Ed. Verner, who is at a loss how it was derived, directed me to write to Scotland but the answers I got were negative. In 1685 the house of one Verner, near Belfast, became shelter for persecuted Scotch refugees after the battle of Rotherwell Bridge. There was a Christian Taverner who brought a dowry to a member of the Gladstone family located in South Scotland.

### ORIGINS OF THE NAME

Variants of the Name include:- Taverner, Tabenor, Tabiner, Tavernor, Taviner, Tavenor, Tabner and of course Tavener. Often the V looks like a u so we get Tauerner.

In a single broadsheet of Taverner Genealogy published by "The Hall of Names" - a very dubious source it says that "William the Conqueror gave land to The Taverners in Essex for their distinguished service to their Leige Lord at the Battle of Hastings. They were lords of the Manor of Uxminster in Essex".

I can find no Uxminster in Essex the nearest name I find is Upminster - Upmynstre in 1602.

In the domesday records of 1083 'Taverner' is not mentioned anywhere in either Essex, Norfolk or Devon

For Upminster 3 owners in lordship are mentioned

1. MAUGER
2. WALTER of DOUAI (Douai is a village 100km south of Lille)  
and
3. HOLY CROSS

Below are the actual entries from the Domesday Book, Essex.

Hundred of CHAFFORD MAUGER holds Upminster from the Bishop which Walfwin held 1 1/2 hides (1 hide = 20 Acres). Then 2 small holders, now the same always 1 plough value 20S now 30S.

Terra Walti de Doui, Land of Walter of Douai. Walter holds UPMINSTER in Lordship which Swein Stewart held as a manor for 6 hides and 30 acres.

Always 8 villagers, then 5 smallholders now 7, always 4 slaves, 2 ploughs in lordship item 5 mens ploughs, now 4. Woodland, 200 pigs, meadow 8 acres, then 1 foal now none, now 85 sheep and 25 sheep value then £7.00 now £8.00. 10 acres lay in this manor which Geoffrey de Mandeville holds in exchange as he states.

(Walter also owned Rainham in Lordship and Holland in the hundred of Tendering).

8.10. Holycross holds Upminster for 2 1/2 hides + 40 acres. Then 8 villagers now 6; then 2 smallholders now 4, then 4 slows now 3. Always 2 ploughs 300 pigs, meadow 6 acres item 20 sheep now 50, then 11 pigs now 30.

I wrote to the Society of Genealogists concerning the Hall of Names information their reply is interesting.

"The paper you enclose is quite worthless from a historical point of view. The name Taverner means 'tavern - house keeper'. In the period in which surnames became hereditary in this country many different and unrelated people would have kept such houses in different parts of the country. They may all have had different backgrounds and ancestries. Whether one was of Norman decent would have no bearing on any other. Certainly nobody of this name can be proved to have been at the Battle of Hastings. Although the name appears on two versions of the discredited Battle Abbey Roll".

The letter by the Director abstracted above makes this line of research somewhat irrelevant.

In another letter to the Essex County Council archives on the same day 9.1.92 I asked for confirmation that the Taverners were associated with Upminster. Jane Smith, the principal archivist replied:-

"I am afraid I have been unable to find any Taverners on Lords of the Manor of Uxminster or Upminster.....". This gives further evidence that the Taverners were not given the Upminster Manor by William of Normandy.

The official origin of the name Taverner is supposed to have sprung up spontaneously during the 12 and 13th century describing anyone who owned a Tavern. For some reason the name was not usual. This is strange since there were more Taverns than Smithies, so there should be more families with the name Taverner than those with the name Smith. \* A recent reference corrects my assumption - see Over.

Another suggested derivation is that a 'Taverner' was a socially elevated wholesaler of wine and spirit. This is interesting since the early Taverner records we have, largely feature courtiers, shipping connections and wine importers. That the Taverners came over with William the Conqueror in 1066 seems unlikely, but what is more likely is that they came over with his court to provisions it with French Wines and Cognacs that no doubt William was accustomed to drink. This could explain why when our first records start in 1260 the Taverners are Lawyers, Barons of the Cinque Ports, Imports & Exporters associated with the King's and Queen's of the day. This connection with the court continues right through to King James in 1618 and beyond.

Our confirmation of this Norman Origin comes from a reference in the Calendar of Genalogica 1272 - 1304.

On page 765 One Nicholas le Taverner a Norman is recorded as having died in Wycombe-atte-Haarede.

My current theory is that somewhat after 1066 once William's court was in full swing the Taverner's started to provision it with wines and spirits and probably export English produce to France as well. As reward the Taverners were given positions at court made assessors of the customs, given titles to land either in the counties or at the important ports of that time.

I have shown elsewhere how well off and prosperous families tended to have a good survival rate and marry well. So that between 1066 and say 1266, 6 or 7 generations could have spread themselves over the countryside and have gained good positions within their chosen communities. Elder sons would have been well educated and probably at court, younger sons would have gone into commerce, the church or the army or navy.

The population of England stayed at about 4,000,000 from the black death in 1348 till about 1560.

The density of population varied from around 25 people per square mile to 5 people per square mile. Essex where many of our ancestors were born had a low population with one of the lowest incomes.

Statistics are available showing population and population densities. This is useful in getting an idea of how many families lived in a county or other geographical area.



TAVERNS - says Haydon's Dictionary of Dates 'published in 1868' - originally owned by George Alfred Chapman, father of Miss Chapman, who owned our house in Taverton. dying here aged 94 in 1976 - may be traced to the thirteenth century

"In the reign of King Henry III 1217 - 1272 only three Tavernes were allowed in London. One in Chepe, one in Walbroke, and the other in Lombard-street." Taverns were restricted by 7 Edward VI (1552-3) to 40 in London 8 in York, 4 in Norwich, 4 in Gloucester 4 in Chester 3 in Hereford, 3 in Worcester 3 in Southampton, 3 in Canterbury, 3 in Ipswich, 3 in Winchester, 3 in Oxford 4 in Cambridge, 3 in Colchester 4 in Newcastle, 3 in Westminster 6 in Bristol, 3 in Lincoln, 4 in Hull 3 in Shrewsbury, 4 in Exeter, 3 in Salisbury (spelman).

The Boar's Head in Eastcheap, existed in the reign of Henry IV (1399-1413) and was the rendezvous of prince Henry and his dissolute companions.

Shakespeare mentions it as the residence of Mrs Quickly and the scene of Falstaff's merriment. (Shakespeare Henry IV)

The White Hart, Bishopsgate, established in 1480 was rebuilt in 1829

Taverns were licensed in 1752

From the Domesday Survey of Essex in 1086 we learn that there were 5 to 10 people per square mile, ie. about 55,000 people in total. The population grew by 25% between 1086 and 1377 in Essex in 1377 the population is estimated at 70,000.

The population controlled by the black death remained fairly constant until Henry 8th reign when in 1538 Thomas Cromwell instigated parochial registration. By 1650 the population doubled, doubling again by 1750 and again by 1840.

In Essex between 1540 and 1680 births and deaths averaged about 7,000 p.a. with marriages at 2-300 p.a.

Essex people were relatively poor and tax was valued at under £5 per square mile compared to Norfolk which was valued at £14 per square mile in 1225.

Of interest also is the population of London which is estimated as:-

450,000	in	1660
575,000	in	1700
675,000	in	1750
980,000	in	1800
2,000,000	in	1841

In early times information is scarce. One useful source of information is the Lay Subsidy of 1327.

In this tax 1/20 of a mans moveable belongings were taxed to pay for protection of the realm against the Scots. In Essex 8,326 people payed tax.

By 1327 surnames were common, but it cannot be assumed that they were hereditary before the mid 1300's.

In 1327 9 Taverners paid tax. For details see below this however does not tell us the total number of Taverners.

#### The Essex Lay Subsidy 1327

Waltero le Taverner of Greenstead.  
Galfrido Tauerner of De Bures and Morten (Braintree).  
Bartholemew Taverner of Coggershale (Nr Braintree).  
Thomas de Taverner of Harlow.  
Johanne Taverner of Newport  
Thoma le Taverner of Raynes Magna (Braintree).  
Jakemanno Taverner of Raynes Magna (Braintree).  
Johanne le Taverner of Halstead.  
Johanne le Taverner of Chelmesford.

By simply ratioing the numbers from 1327 we can estimate that Essex had 80 - 120 Taverners in 1327, and if the Essex population was 70,000 then 1 in 700 was a Taverner, and the birth and death rate would have been approximately 10 per year with one Taverner marrying every 2-3 years. This give a guide when assessing progress in finding all the Taverners in an area.

Volume 1 of the Taverners was circulated to many County Libraries as well as those people who contributed to it. One of the largest sources - and most costly was Debrett, they wrote 7 reports for me.

With the copy I sent to Debrett I asked their opinion as to how many Taverners were still likely to be missing.

Their opinion - and they should know if anyone does - is that I have about 1/2 the Taverners from 1600 and about 1/3 of those before 1600. Again this is very interesting since we can be pretty certain having tracked down a family to a village that we are probably dealing with relations, even if a direct connection cannot be established.

### CHAPTER 3

#### The Taverner Coat of Arms.

It seems that The Taverners became preoccupied with a coat of Arms around 1575 and after.

During March 1993 I wrote to the College of Arms to find out whether I was truly entitled to use the Coat of Arms of the Taverner family.

For a suitably large fee the Chester Herald wrote listing the entries. For those readers interested in this aspect of Genealogy I attach this report in full. It is rather interesting that the visitations to the various branches of the Taverners produced significantly different family histories.



D.H.B. CHESHYRE, LVO, MA, FSA, CHESTER HERALD,  
COLLEGE OF ARMS, QUEEN VICTORIA STREET,  
LONDON, EC4V 4BT. TEL: 071-248 1137.

19 March 1993

J P Tavener Esq  
238 Hesketh Lane  
Tarleton  
Lancs

Dear Mr Tavener

Further to my letter of 10 February the searches which you asked me to make in the official registers of the College in the surname Tavener and obvious variant spellings, to enquire into your own right to arms, have now been completed. I write to report on the results which may be summarized briefly as follows:

Eleven different entries have been located concerning early Tavener arms as follow:

1. N G. 35 A trick (or black and white drawing of arms indicating tinctures) is included which may be blazoned as: (Arms) Argent a bend lozengy Sable in the sinister chief a torteau and (Crest) Out of a ducal coronet a tree (species not shown) Proper which for ease of reference I will call Coat and Crest A. The text recites that 'These Armes and Creast were confirmed to Roger Tavernor of the Countie of Essex esq by Sr Gilbert Dethick Knight als Garter ..... (blank) day of May 1575'.
2. Dethicks Grants 36b. A similar entry to (1) of ?sixteenth century origin.
3. Vincent 162.169. A further entry expands with the text "Roger Taverner of Upminster ..... hath of longe time bene one of the bearers of .... Armes ..... Argent a bend lozinge on the Dexter side a Tourt Gules and to his Crest On a Torse out of y Crowne Gules an Oak tree pper (ie proper) Acorns golde ..... assigned unto his said Auncient Armes the said Crest .....". This is dated May 1575 and is accompanied by a coloured drawing of Coat and Crest A.
4. Camdens Grants 3.27. This shows entries of Coat A with both early and later Crests (see other entries).

Marque + de l'heraldie m  
Nicholas T. de l'heraldie m  
(Roger in his)

5. C21.49 (Essex Visitation of 1634) (see paragraph 15). This contains a trick of Coat and Crest A with the text "this Creast was given to the saide Roger in regard of his Office of Generall Surveyor to her Maj(esty)". Another entry shows the later Crest (see other entries).
6. EDN. 56.70b This entry concerns a patent of arms dated February 1614 and shows a trick of Coat A (showing an annulet Gules in sinister chief as opposed to a torteau) named for "Taverner of Hexton in Hertford". A Crest is also shown which may be blazoned as: a Dove Argent beaked and legged Gules holding in its beak a branch (no species shown) Vert, which I will call Crest B.
7. Camden 2.29b. This entry refers to "Francis Taverner of Hexton in Com Hertford 15 Feb 1614" and includes a trick of Coat A and Crest B in which the dove's legs are shown Gules.
8. Misc Grants 7.326. This entry expands that in (6) with text reciting that "ffrancis Taverner of Hexton in the co. of Herts son of Peter Taverner of Hexton son of Richard Taverner of Woodeaton co. Oxford Esq eldest son of John Taverner of North elmeham in (blank) Norfolk and brother of Roger Taverner of Upminster in Co. Essex". The blazon shows Crest B as: a dove volant with an olive branch in her mouth.
9. NG. 114. This is a similar entry to that in (6).
10. Camden 1.14b. This also seems to be basically similar to that in (6).
11. 2H5.127b. This entry contains the text of a Grant of Arms by William Camden dated 2 March 1613 (-14) which exemplified and confirmed to "Roger Taverner of Upminster co Essex Esq lineally descended from the ancient house of the Taverners of North Ellingham in Norfolk the ancient arms appropriated to the said family viz Argent a bend fusily Sable on the chief sinister point a Torteaux". The Grant also included "Francis Taverner of Hexton in Co Herts son of Peter Taverner of Hexton aforesaid son of Richard Taverner of Wood Eaton co. Oxford Esq eldest son of John Taverner of Wood Eaton aforesaid and brother to the above named Roger Taverner". The text further recites that the King of Arms "exemplifies ratifies and confirms the said Arms to him by right ancestral belonging and also to restore the ancient Crest thereunto appertaining viz a Dove volant Argent with Wings an olive branch in his beak."

The following pedigree entries recorded here during the period of the Herald's Visitations, which took place between about 1530 and 1685, show a further nine Taverner entries:

12. The Herald's Visitation of Hertfordshire in 1572 includes a five generation pedigree headed by John Taverner of North Elmham who was "son of Nicholas son of Henry of North Elmham who was descended from Warin le Tavernor who lived in North Elmham in the reign of King Henry III as by a deed sealed with ye seal of Arms of the said Warin appeareth". This John Taverner died aged 88 in 1545 having married firstly Alice daughter and sole heir of Silvester of North Elmham and secondly Anne Crane. The pedigree is carried down to the children and grandson of Peter Taverner of Hexton by his wife Francis Docura. The entry includes illustrations of Coat A together with renderings of the seals of the family's ancestor Warin in which it was noted that "the armes in this seale is lossengye and not fucellye as some have suposed". No further genealogical details are included here which are not shown in the extensive printed pedigree referred to in paragraph 14.
13. The 1633 - 4 London Visitation includes a three generation pedigree headed by Robert Taverner of Arnwayes co Essex who was father of Thomas Taverner of the same place who married Anne (blank) and had issue: Robert; Thomas of London merchant tailor (who signed the pedigree) who married Margaret daughter of George Smyth of Mitcham Surrey; and William. No arms are shown with this entry.
14. The 1634 Hertford Visitation includes a five generation pedigree headed by John Taverner of North Elmham carried down to his numerous descendants. A trick of quarterly arms showing Coat A quartering Silvester is included together with a rendering of Crest B. I enclose photocopies taken from the Harleian Society's printed version of this pedigree which more or less corresponds with ours.
15. The 1634 Essex Visitation includes two five generation pedigrees headed by John Taverner of North Elmham by his wife Alice Silvester. One of these shows the descendants of Roger Taverner of Upminster together with a trick of Coat A and Crest A (with a crescent for difference) while the other pedigree shows the descendants of Robert Taverner of Arnoys together with a trick of quarterly arms depicting Coat A quartering Silvester and a rendering of Crest B. I enclose photocopies taken from the Harleian Society's printed version of these pedigrees which more or less corresponds with ours.

16. The 1634 Oxford Visitation includes a four generation pedigree headed by Richard Taverner of Woodeaton and his two wives Margaret Lambert and Mary Harcourt including a trick of Coat A only. A few extra details are shown here which do not appear in the pedigree referred to in paragraph 14 but nothing of great genealogical significance.
17. The 1664 Norfolk Visitation includes a three generation pedigree headed by Thomas Taverner of North Elmham who was father of Henry Taverner of the same place who married Anne Rogers of the City of Westminster by whom he had issue a son Charles. No arms are shown here.
18. Another version of the 1664 Norfolk Visitation includes a trick of Coat A only named for Charles Taverner of North Elmham.
19. The 1664 Essex Visitation includes a three generation pedigree headed by John Taverner of Upminster who married Susan Davis by whom he had a son Roger Taverner of Upminster who married Anne Harrington and had issue. A trick of Coat A together with a Crest depicting an oak tree only is included. I enclose a photocopy of J J Howard's printed version of this pedigree which more or less corresponds with ours.
20. The 1668 Oxford Visitation includes a five generation pedigree headed by Richard Taverner of Wood Eaton in that county who married Margaret Lambert and is carried through to the descendants of their grandson John who signed the pedigree. A trick of quarterly arms is included showing Coat A in the paternal quarter with an inescutcheon of pretence for (?) Smithies together with a rendering of Crest B.
21. An early entry in a volume concerning heraldic funerals concerns Richard Taverner of Wood Eaton co Oxford who died 24 July 1575 "at his manor house of Wood Eaton" and was buried 29 July following in the parish church. Some genealogical details are included but they contain no further information than already reported on.
22. A short search in some printed material (which are not part of our official records) revealed further information from the Harleian Society's versions of the Visitations of Norfolk and "Miscellaneous Essex Pedigrees" of which I enclose photocopies together with Taverner entries from the "Dictionary of National Biography" which gives an interesting resume of the life of the Richard Taverner who is so much referred to in this report.



23. All the other records of pedigrees and Grants of Arms dating from about 1685 to the present time were examined without finding any further entries in the surname Tave(r)ner.

In conclusion although a great amount of ground has been covered I regret that I can find no evidence that George Taverner (whose son was baptised in 1657) or any of his descendants shown on that or any of the pedigrees you sent ever established a legal right to arms or registered genealogical particulars about themselves here. In order for you to claim a right to arms you would need to prove (with documentary evidence) and record here a legitimate unbroken male line of descent from one of the individuals shown on one of the Visitation pedigrees named in paragraphs 12 to 21.

Unfortunately all your successful work in proving your descent seems to fall short by one or two generations which is especially disappointing considering your ancestors lived in the same area as the main family. Perhaps further genealogical research in other categories of records (? in the Public Record Office) might give you the link you need?

If you are able to prove your link eventually I should be happy to be of further assistance if you decide to establish your right to Coat A.

Yours sincerely



Chester Herald

*Harleian Society*  
 C25. 13. 1. ...  
**Taberner of Hextonbury.**

ARMS.—Quarterly—1 and 4, Argent, a bend lozengy Sable, in sinister chief a torteaux; 2 and 3, Ermine, on a chevron Sable three crosses engrailed Argent, SILVESTER.

CREST.—A dove with wings expanded Argent, in the beak a branch of laurel Vert.

Alice, da. and heir of John Taverner—Anne Crane of Norfolk, was the  
 Robert Silvester of of North Elm- 2 wife of John. Her sister was  
 North Elmham, co. ham, co. Norf. the mother of Sir John Petty of  
 Norf., 1 wife. Norfolk, Kt., father of Sir  
 Augustin Petty, Kt.

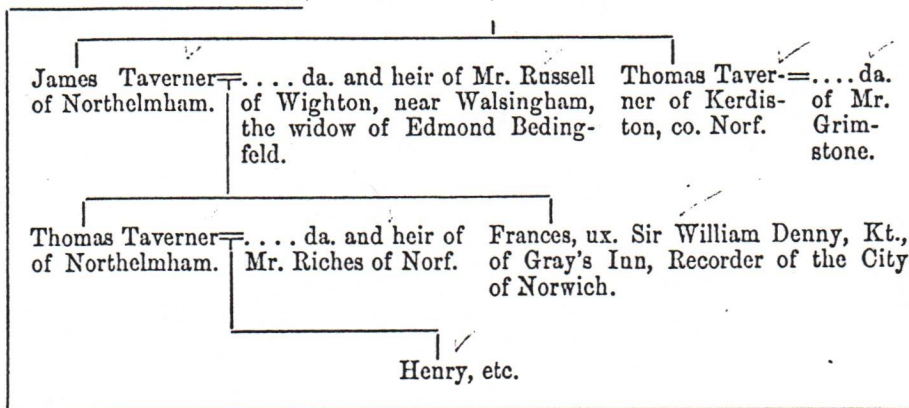

P96

2. Roger Taverner of Upminster, co. Essex, Esq., Surveyor of the King's Wood on this side Trent. . . . da. of

. . . . da. of . . . . Wentworth—John Taverner of Upminster, . . . sister of Sir  
 of Lillingstone in Northamp- Surveyor General of the Woods Henry Whitehead  
 ton, and had no issue by her. to Q. E. and K. James on this of co. Hants.  
 side Trent.

Roger Taverner of Upminster, now living.

. . . . da. of Sir John Harecourt of Stanton 1? Richard Taverner of Wood—Margerett, da. of Walter  
 Harecourt, Kt., 2 Eaton, co. Oxford, was Clarke Lambert, grandfather of  
 wife. of the Signet to H. 8 and E. 6, Sir Oliver, Lord Lam-  
 Justice of the Peace, and High bert, Kt., 1 wife.  
 Shreeve of Oxon 12 Eliz.

Harecourt Richard—. . . . da. Peter Taverner—Frances, da. of Tho-  
 Taverner. Taverner of Francis of Hexton, co. mas Dockwra the  
 — of Wood Heyton of Hertf. elder of Putteridge  
 Penelope, ux. Eaton. Surrey, Esq. in Hertf., Esq.
 Mr. Pettitt.

Francis—Jane, da. of George John Taverner, Margerett.—Edw. Wingate  
 Taverner Needham of Wim- Professor in of Welwyn, co.  
 of Hex- ondly Priory, co. Gresham Col- Hertf.  
 ton, Esq., le, p'son of  
 Justice of Hertf., Esq. Newington.  
 Peace.

Richard Jane. Edward Win—Mary, da. and heir Frances, ux. Eustace  
 Taverner. of Wel- of Raffle Allway of Needham of Wim-  
 wyn. Cannons, co. Hertf. ondly.

C D

**Taberner.**

ARMS.—Argent, five lozenges in bend sable, in sinister point a torteau.  
 CREST.—An oak-tree argent fructed or.

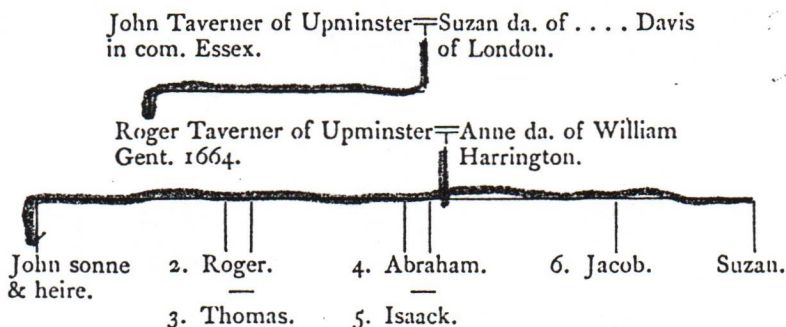

ROGER TAVERNER.

**Taberner.**

(Harl. MS. 1541, 226<sup>b</sup>.)

Henry Taverner of North Ellingham (? Elmham) in com. Norf. descended from Waren le Taverner who lived at North Ellingham temp. H. 2 as by his deed appeareth sealed with his seal and arms viz. a bend fusily.

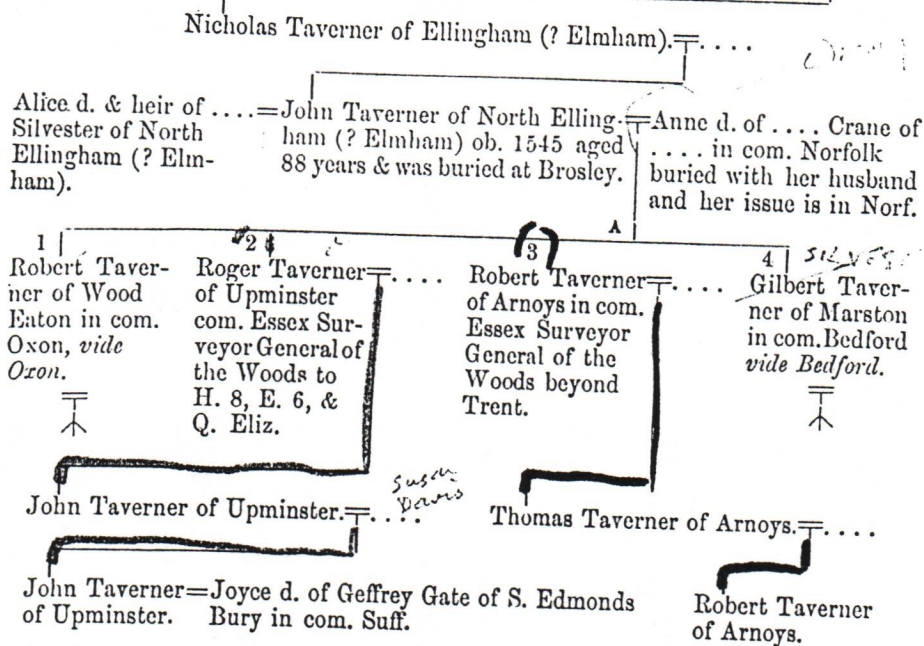

(See Pedigree of this Family in Vis. of Hertfordshire, 1634, Harl. MS. 1547, 16.)

C 3 D

Jane, ux. Thomas Waynman of  
Witney Park, Esq., brother of  
Sir Richard Waynman, Kt.     Margeret, wife to Mr. Freer of  
Water Eaton, Esq., father of  
Sir Edward Freer, Bart.     John Taver-  
ner, Clerk,  
ob. s.p.

Edmond Taverner of Soundess, co. Oxon,  
Esq., Justice of Peace.     Lucy, da. of  
Hales of Warwickshire,  
Esq.     Martha.     George Calfeld of Graies  
Inn, Esq., Judge of  
Assize in Wales.

John Taverner of Soundess,  
Esq.     ... da. and  
co-heir of ...  
Smyth of ...  
co. Somerset.     Edmond Taverner,  
Esq., Secretary to  
Philip, Erle of Pem-  
broke, Chamb'lain of  
his Ma'ties howse-  
hold.     Mary, ux. ... Hills.  
Sir William Calfeld, Kt.,  
Lord Calfeld  
in Ireland.

Edmond, born in November 1629.     Edmond Hills.

Margerett, ux. ... Newgate  
of Norf.     Robert Taverner of Arnoys,  
co. Essex [Arneways in  
Lambourn].     ... da. of ... Newcomen  
of Saloby [Saltfleetby], co.  
Linc.

Thomas Taverner of Arnoys, co. Essex.     ANNE  
... da. of ... Griffith of London.

Robert Taverner of Arnoys, now  
living.     ... da. of ...  
Godman of Surrey.     Dunen, Procter  
of London, 1 ux.     Thomas Taverner  
of London.     MARGARET  
... da. of ... GEORGE  
Smyth of Mit-  
cham in Surrey.  
MERCHANT  
TAILOR

WILLIAM.

### Taberner.

(No. 1.)

ARMS.—Quarterly—1 and 4. TAVERNER, same as in next pedigree. 2 and 3. Ermine on a chevron sable three crosses engrailed argent (SILVESTER).  
 CREST.—A dove with wings expanded argent, in the beak a branch of laurel vert (TAVERNER).

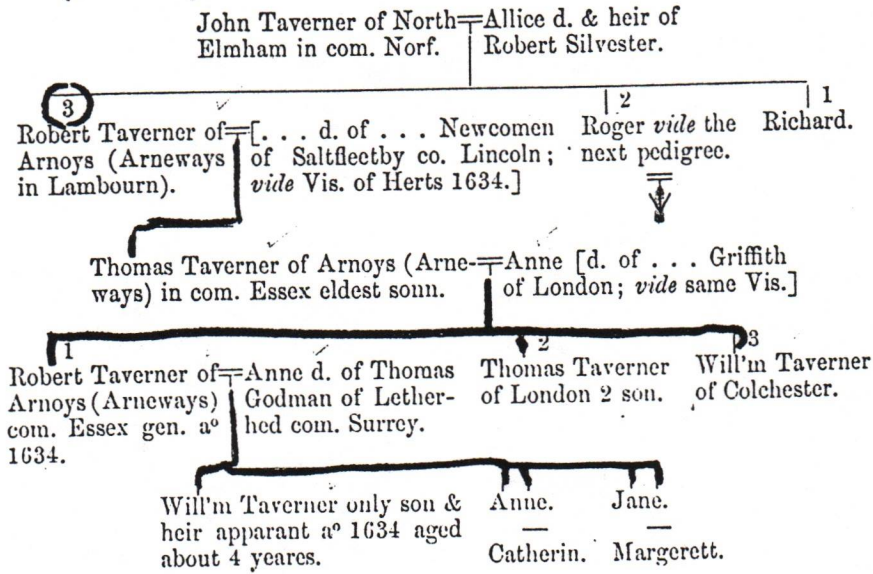

THE VISITATION OF ESSEX, 1634.

### Taberner.

(No. 2.)

ARMS.—Argent, a bend lozengy sable, in sinister chief a torteaux, a crescent for difference. [TAVERNER].  
 CREST.—Out of a ducal coronet an oak tree vert, fructed or. [TAVERNER.]

A confirmation of these Armes & graunt of the creast under the hand & seal Sr. G. Dethick Garter dated the 3<sup>d</sup> of day of May aº 1570 the vii<sup>th</sup> of Q. Elizabeth to Roger Taverner of Upminster within the county of Essex esqr. lineally descended from the auntiant howse of the Taverners of Northelmham in Norf.

This creast was given to the said Roger in regard of his office of general Surveyor to her Majesty.

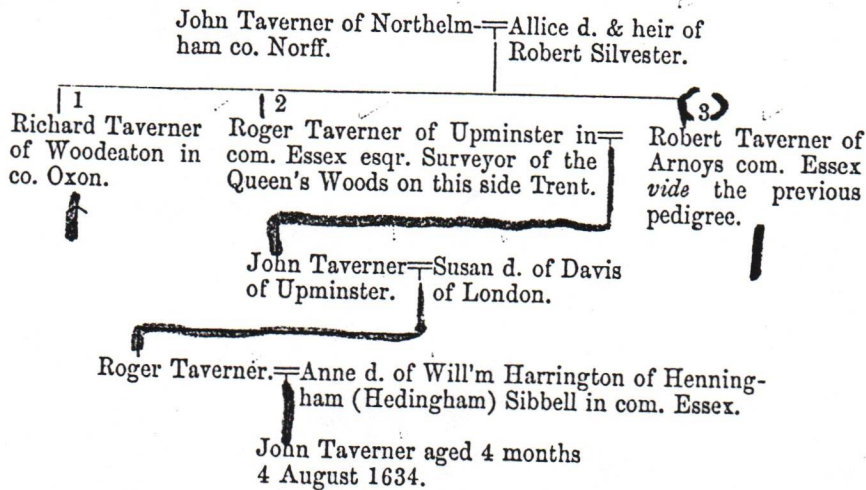

Harleian Society

### Taberner.

Harl. 1552, ink. fo. 256<sup>b</sup>, pencil 251<sup>b</sup>.

Henry Taverner of North Elmham in co. Norfolk, descended from Warren le Taverner who lived at North Elmham temp. Hen. II., as by his deed appeareth sealed with his Seal of Arms, viz., a bend fusilly.

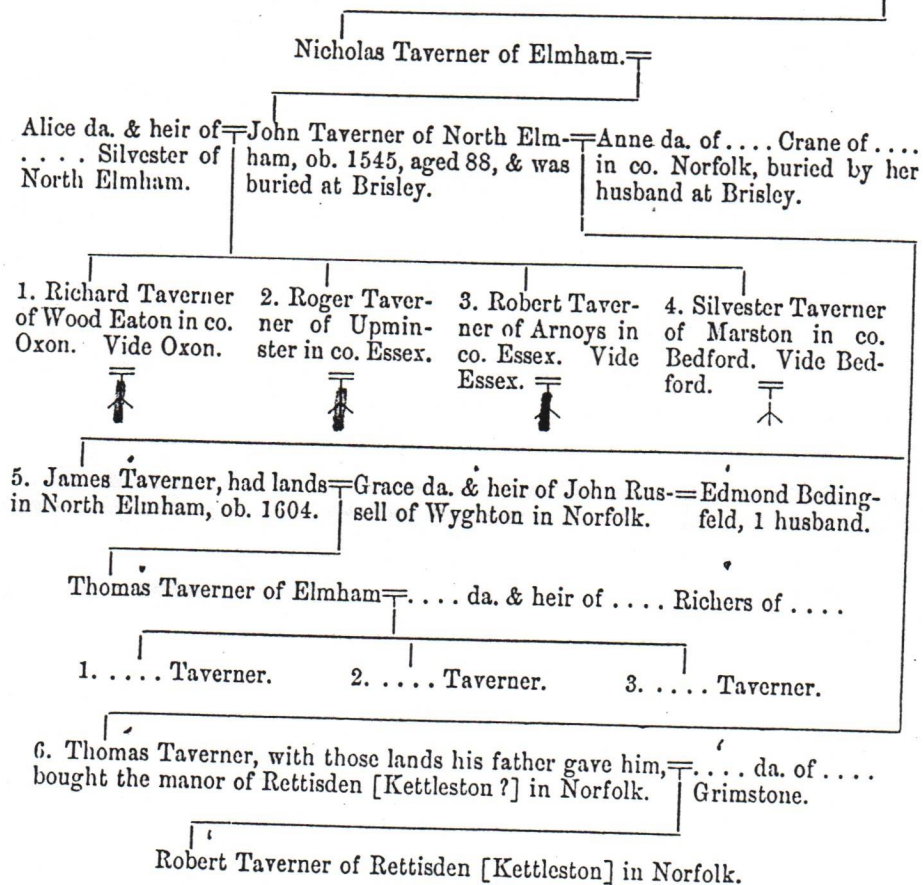

## TAVERNER

I and IV argent a bend of lozenges sable II and III ermine on a chevron sable. Three crosses eng, coupé argent. Overall a crescent on a amulet for difference.

Crest, A dove, wings expanded argent, in the beak a slip of olive vert. Conf, by R. St George Clar and Hen St George, Richmond and entered at the visit of London in 1634 for Thomas Taverer of London, 2nd son of Thomas Taverner of Arnoys in Essex, eldest son of Robert of Arnoys who was third son of John Taverner of North Elmsham in Norfolk by Alice daughter and heir of Robert Silvester.

The same quartered coat with a nuellet only on the coat and crest for difference: confirmed by R St George Clar, to John Taverner of Sowndels co Oxon son and heir of Edmund Taverner of the same who was third son of Richard Taverner of Woodeaton, co Oxon son and heir of John Taverer of North Elmeham, Norfolk, by Alice his widow daughter and heir of Robert Silvester of North Elmeham.

A Third shield is tricked the same but with this coat in the 2nd quarter on a fesse between three snakes twisted with their tails in front azure, as many doves argent.

Harl 1428 f 6d and 7.

(This third crest is that of John Taverner Rector of Stoke Newington from 1628 - 1638. (see picture in brown photo book).

Ref: Holsworthy papers society of Genealogist.

### Other Heraldic References:

Ref: Fairbairn's crests of the families of Great Britain and Ireland.

"Taverner Essex, Kent & Herts. Out of a ducal coronet, gu an oak tree fructed"

"Taverner Essex, Kent & Herts. A dove wings expanded ar, beaked and legged gu, in its mouth a branch of laurel vert".

Ref: The General Armory. Burke's Peerage Ltd.

"Taverner (Hexton Co Hereford, and Co Kent granted 1575 and by patent 1604). Argent a bend lozengy sable in the sinister cheif a torteau.

CHAPTER 4

Taverners County By County Ref: 1992 IGI

The counties can be divided roughly into 3, those in which we find NO Taverners, those containing a few Taverner, and those where a large number of Taverners have lived - and usually owned property.

VOL 2. Focuses on pre 1700.

Firstly those counties Tavernerless. Berks, Cheshire, Cumberland, Dorset, Durham, Hants, Monmouth, Northumberland, Notts, Shropshire, Somerset and Westmorland.

Next those with a few Taverners:-

Buckinghamshire

Thomas Taverner married Agnes Man 1581 at Lavendon.  
John Taverner married Margery Swayne 1611 Long Crenton.  
Alice Taverner married Richard ? 1625 Beaconsfield.

Richard son baptised 1700	}	To John & Daramis
Thomas son baptised 1694	}	Taverner at Drayton
Elizabeth daughter baptised 1685	}	Parslow.

At High Wycombe

John Taverner married Susan Chamberlaine 1612  
Richard Taverner married Elizabeth Hunte 1616  
Thomas Taverner married Katherine Raveninge 1631  
Susan Taverner married Meridethe Joanes 1632  
Joane Taverner married James Rayner 1636  
Edmund Taverner married Jonne Young 1659  
Joan Taverner married Christopher Martin 1670  
Edward Taverner married Sarah Fox 1685  
Elizabeth Taverner married William Ratcliffe 1685

Clearly High Wycombe would bear further investigation. It is odd that there are no births listed.



**CAMBRIDGE**

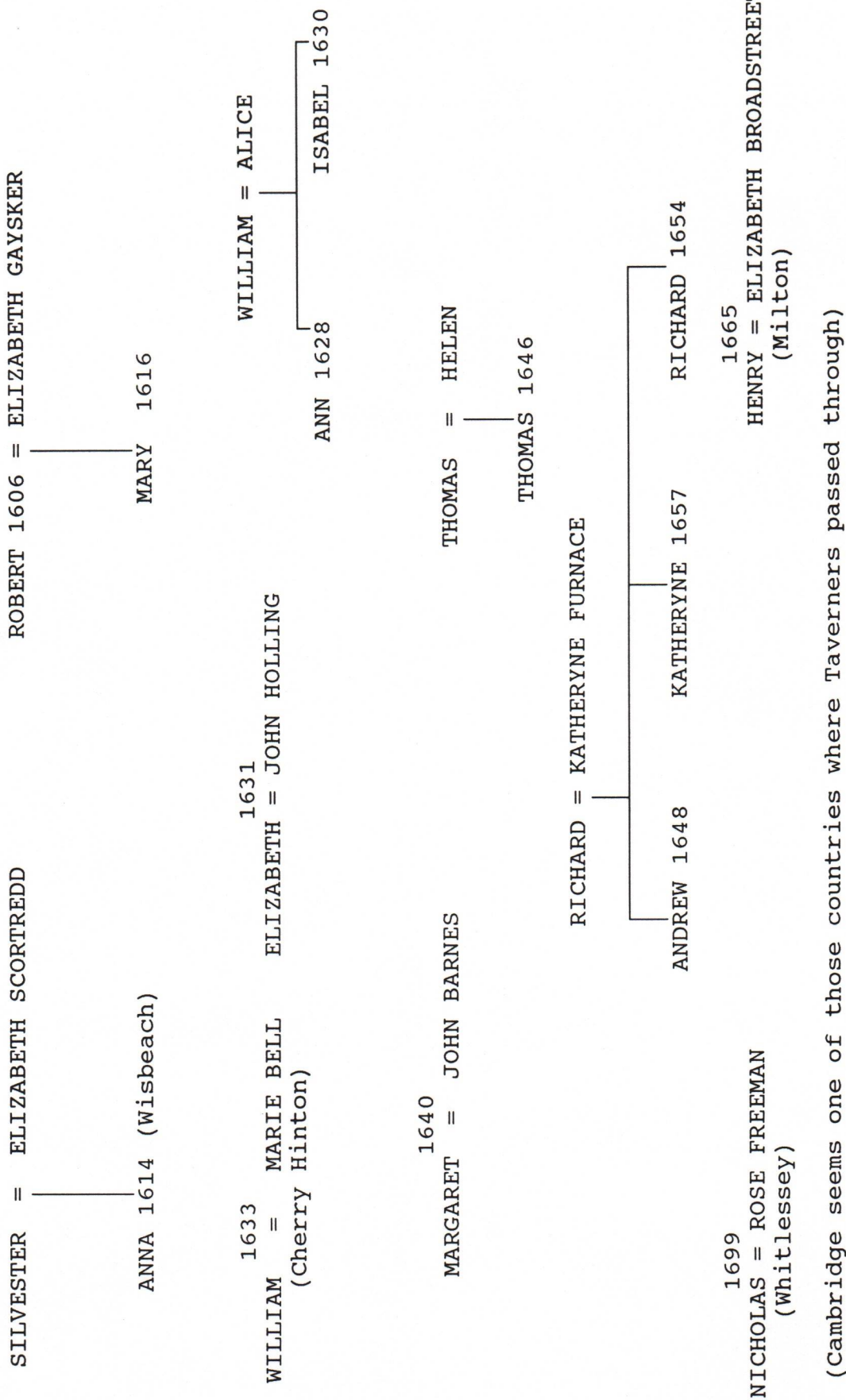

(Cambridge seems one of those countries where Taverners passed through)

Cornwall St Teath

Jana Taverner married Petrus Dagge 1571  
Alicia Taverner married ? 1588  
Margaretta Taverner married Moses Langforde 1603  
William Taverner married Grace May 1626  
Alice Taverner married Robert Porter 1663  
William Taverner married Philippe Philipps 1681  
Grace Taverner married John Williams 1701

Margaret Taverner married William Hocken 1651 at Michaelstow.

Again St Teath would be an interesting parish to study.

Derbyshire

Cicilie Taverner married William Cryer 1544 at Wilne  
Thomas Taverner married Sibil Kitchen 1575 at Horsley  
Ann Taverner married James Gyll 1638 at Dronfield  
John Taverner married Elizabeth Pegg 1693 at Derby - St Peters  
William Taverner married Judith Carver 1693 at Derby - St Peters

Gloucester at Kemerton

Marye Taverner baptised of William & Frances Taverner 1619  
Thomas Taverner baptised of William & Frances Taverner 1622

Bristol

Thomas Taverner married Rebecca Cole 1673  
Margaret Taverner married William Ireland 1670

Hampshire - at Dibden

Mary Taverner married Martin Carter 1687

Hereford - at Cradley

Johes Taverner married Annah Hill 1579

Lancashire - at Wigan

James Taverner baptised of George 1614  
Jane Taverner baptised of George 1627  
Peter Taverner married Ann Gaskill 1693

Oxfordshire

Penelope Taverner Baptised of Richard 1566 Woodeaton Married  
Robert Petty c. 1590 of Woodeaton.  
Richard Taverner married Mary Harcourt c. 1565 of Woodeaton  
William Taverner baptised 1557 Aston Rowant

1567 Thos Yate = Margaret Taverner

1592 Thos Freeman

Richard  
Godfather Richard Taverner

1558 John = Joan Kent, Oxford City

1593 Marie = Edmund Hill, Gent, St Peters in the East, Oxford.

(1600 London, Christian Taverner married Richard Hill)

Rutland - at Oakham

Elizabeth Taverner married William Firkell 1585  
Robert Taverner married Ann Glen 1583 Oakham

Staffordshire at Tamworth

Joan Taverner married Mathew Smartwood in 1572  
Agnes Taverner married Richard Garrett in 1573  
John Taverner married Elnor Orton in 1581

At Eccleshall

Also Taverner married Robert Richards 1592

At Walsall

Elizabeth Taverner married Christopher Hayes in 1605

Suffolk

John Taverner married Joan Gylys 1544 Kelsale  
John Taverner married Christian Siggin 1570 Rendham  
Margery Taverner married Robert Mason 1575 Eye  
Francis Taverner baptised of James c.1582 Beccles  
John Taverner married Dorethie Daldy 1621 Kenton  
Baptista Taverner married Ann Turner 1624 at Eye  
Rosa Taverner baptised of Robert & Ann Taverner 1640 Glemsford  
Franciscus Taverner baptised of Robert & Ann Taverner 1643  
Glemsford  
William Taverner baptised of Franciscus/Martha 1684 Glemsford.

Scotland

Only 1 pre 1700 at Angus, Dundee:-

Angus of George & Issabell Huchinson 1650.

Surrey

Ann Taverner & James Jeffrey 1767 Southwark  
John baptised of Richard Taverner 1583 K.U. Thames  
Richard baptised of Richard Taverner 1585 K.U. Thames

Sussex

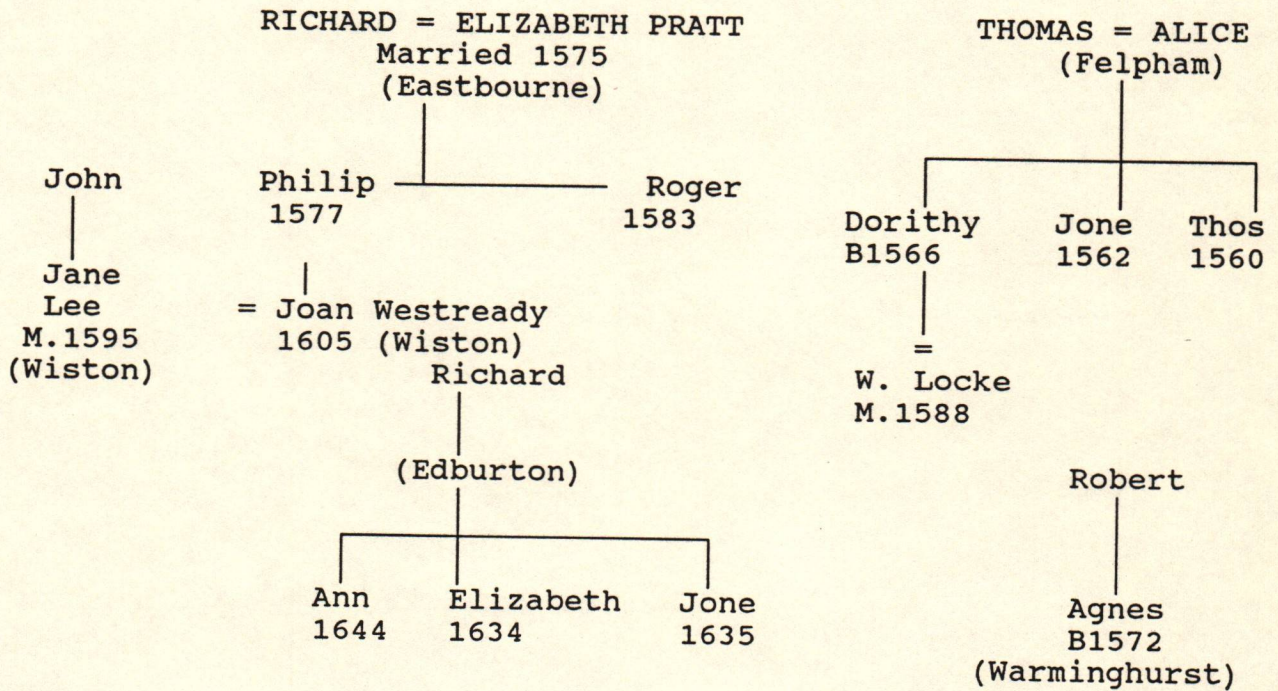

Michael Taverner married Joane Hiberdon in 1582 at Birdham  
 Alice Taverner married Robert Duyt in 1577 at Arundel  
 Andrew Taverner baptised in 1561 at Arundel  
 Elizabeth Taverner married Michael Ryles in 1602 at South Bersted  
 Alice Taverner married Philip Anyse in 1604 at South Bersted  
 Cicily Taverner married William Boxall in 1641 at E. Mardon  
 Isabel Taverner married Philip Allcharne in 1631 at Rotherfield.  
 NB. Mary Harcourt married Cromwell Lee 1576.

*William Taverner of Donwich, Suffolk who had a  
 Corrodie in the Abbey of Siston, Suffolk 1317*

**Wiltshire** at Chippenham

Baptised of George Taverner

George 1624

Richard 1627

Margery 1629 (she married William Looker 1668)

William 1633

Jane 1636

Margaret 1640 (she married John Short 1685)

Baptised of William Taverner (George's son)

Ann 1662

William 1665

Susanna 1666

Baptised of Richard Taverner (George's son)

Elizabeth 1660

Mary 1665 (she married John Pollard in 1680)

William Taverner had baptised (William's Son)

Elizabeth 1696

Grace 1689

Mary 1694

William 1699

Richard Taverner married Ann Powell 1682

Edith Taverner married John Sokrell 1681

Elizabeth Taverner married Thos Mayer 1681

Giles Taverner married 1672 Susen Rinell at Yatton Keynel

married 1694 Abigale Hand at Yatton Keynel

married 1699 Mary Parsons at Yatton Keynel

Ann Taverner married John Page in 1683 at Calne

Pawle Taverner married Mary Danntecye ? in Trowbridge.

**Worcestershire** at Pershore

Baptised of William Taverner

Richard Taverner 1543 (married Isabella Burke 1575)

George Taverner 1546

John Taverner 1549

Baptised of John Taverner

Mary 1570

Margaret 1569

Elizabeth 1576

William Taverner was baptised 1565, and had a son Richard baptised in 1586. Richard married Elizabeth Bates in 1630 and they had two sons Henry baptised at Worcester 1624 and William at Pershore in 1639. William married Ann ? at Pershore in 1675.

Wills in the York registry

- 1429 John - Chaplain - Ripon
- 1475 John @ Belson York, Vintner
- 1448 Joan, wife of Robt. of York
- 1429 Robt. of Bridlyngeton
- 1408 Thoms, Bur st Olaves York
- 1472 John - Ripon
- 1485 Thomas of Kexby
- 1502 Edmund of Drip all
- 1548 Richard of Atwikke
- 1546 Richard of Pidesburton
- 1566 W<sup>m</sup> of Ottingham
- 1617 Dorothee of Estricke
- 1614 Edward "



**BEDFORDSHIRE**

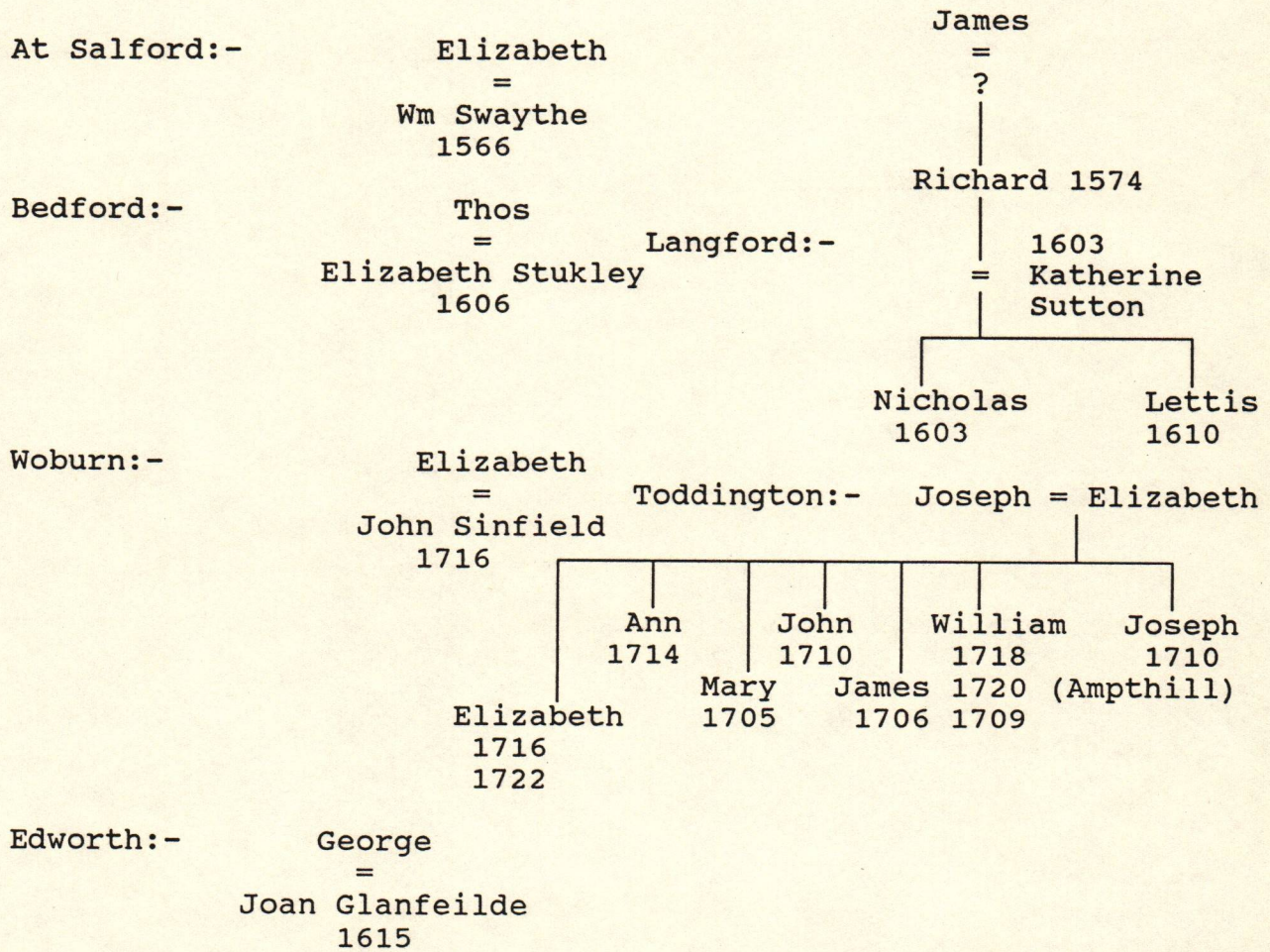

**BEDFORD**

John Taverner Matric, Sizar, Queens 1603 of Bedfordshire 1606-7 MA 1610. Perhaps Vicar of Hackington, Kent 1613-15 died 1615.

*Astwick*  
*W<sup>m</sup> Taverner m.*  
*25<sup>th</sup> Oct. 1619*



**BEDFORDSHIRE**

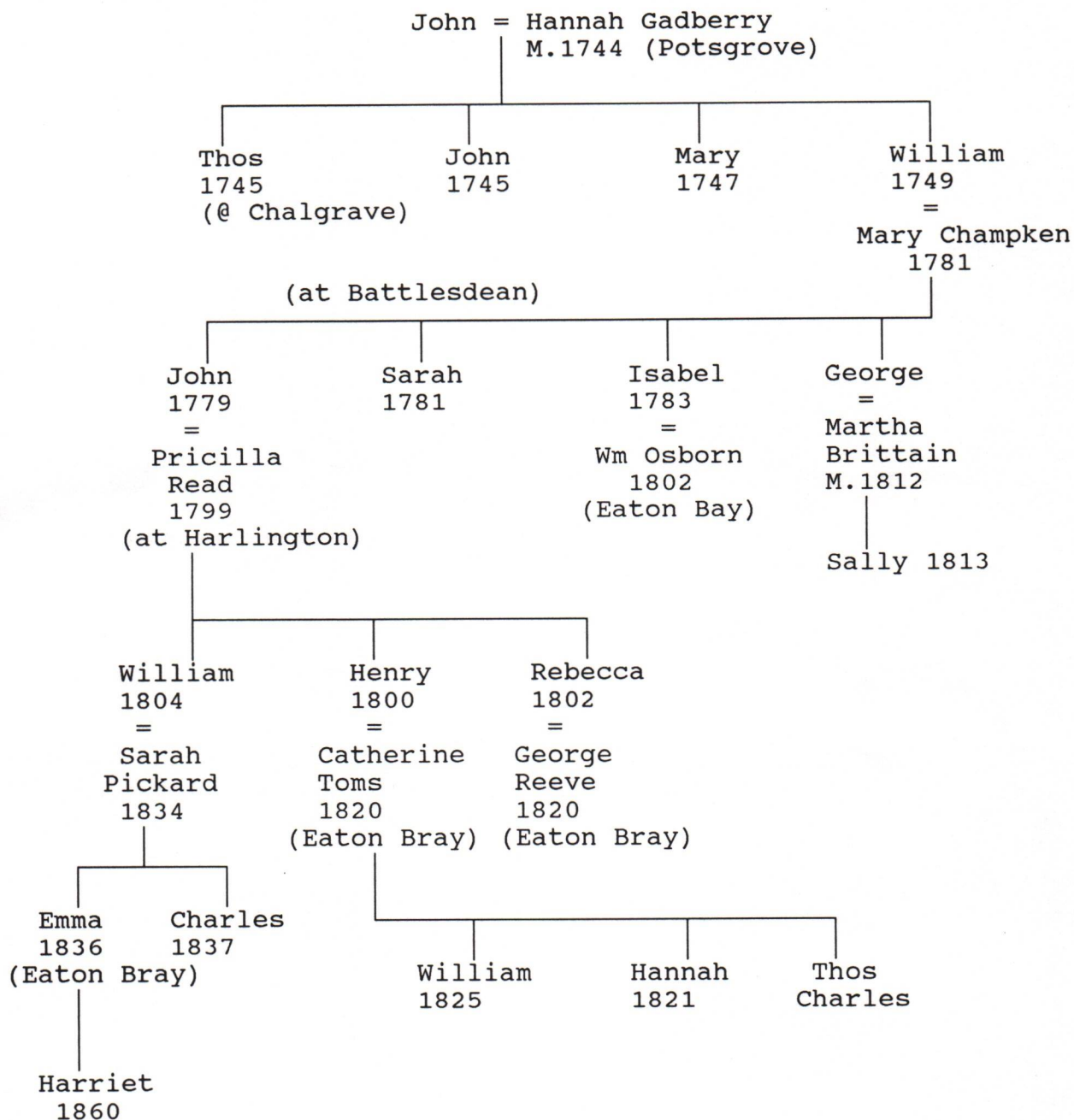

**BEDFORDSHIRE**

**LEIGHTON BUZZARD + EATON BRAY**

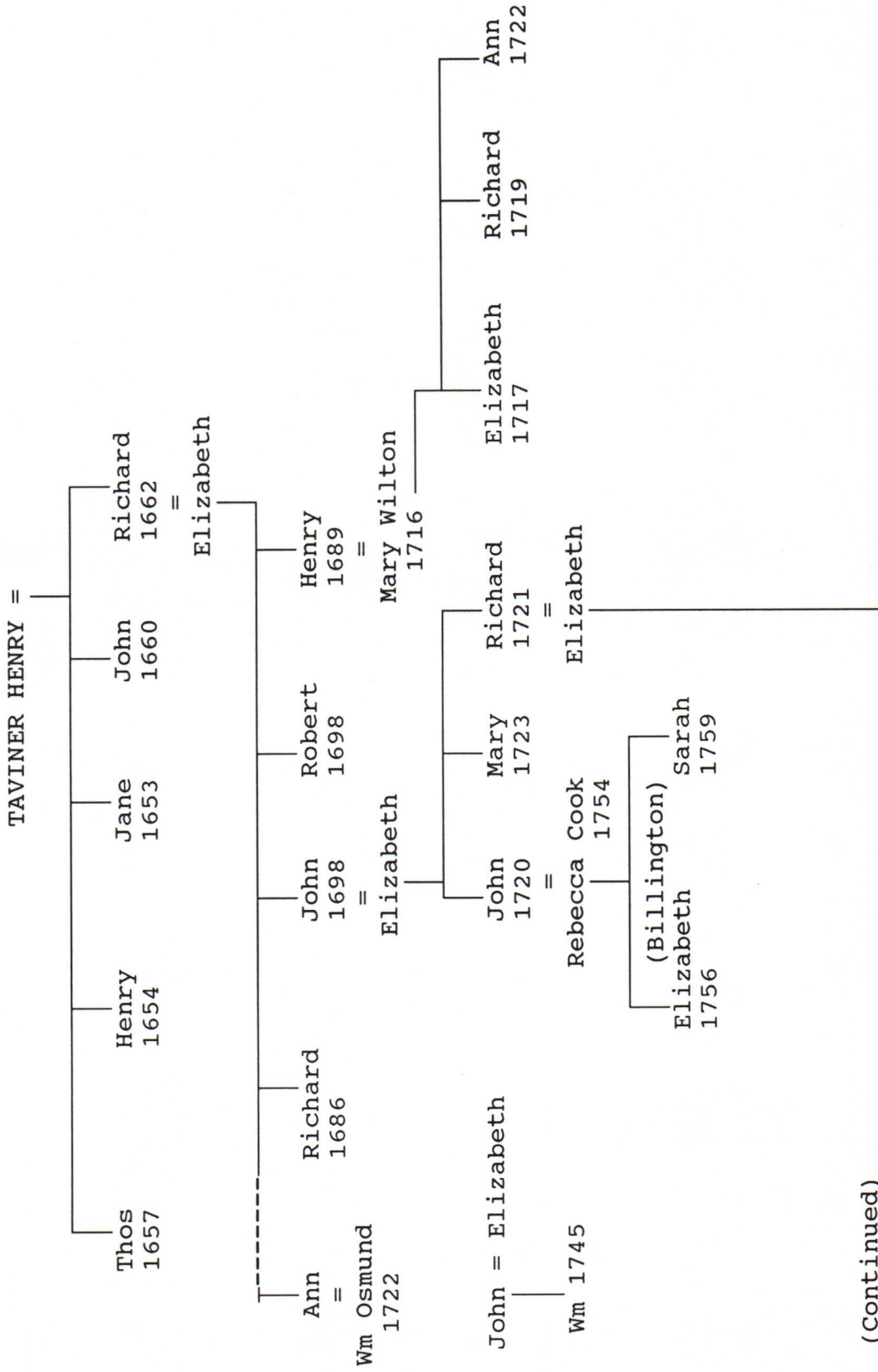

(Continued)



(Continued)

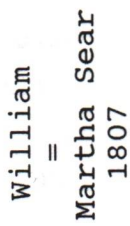
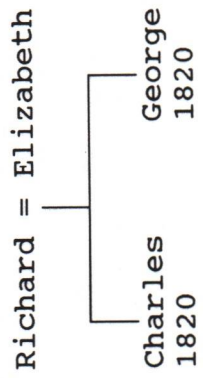

William = Elizabeth

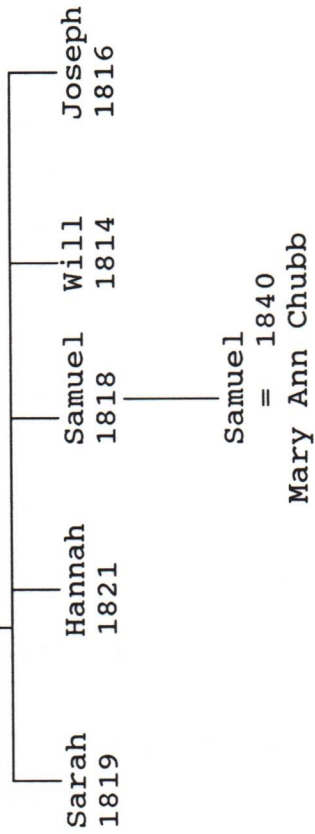

James  
= 1810  
Sarah Grantham

William  
= 1821  
Mary Parrot

**BEDFORDSHIRE, SOUTHILL**

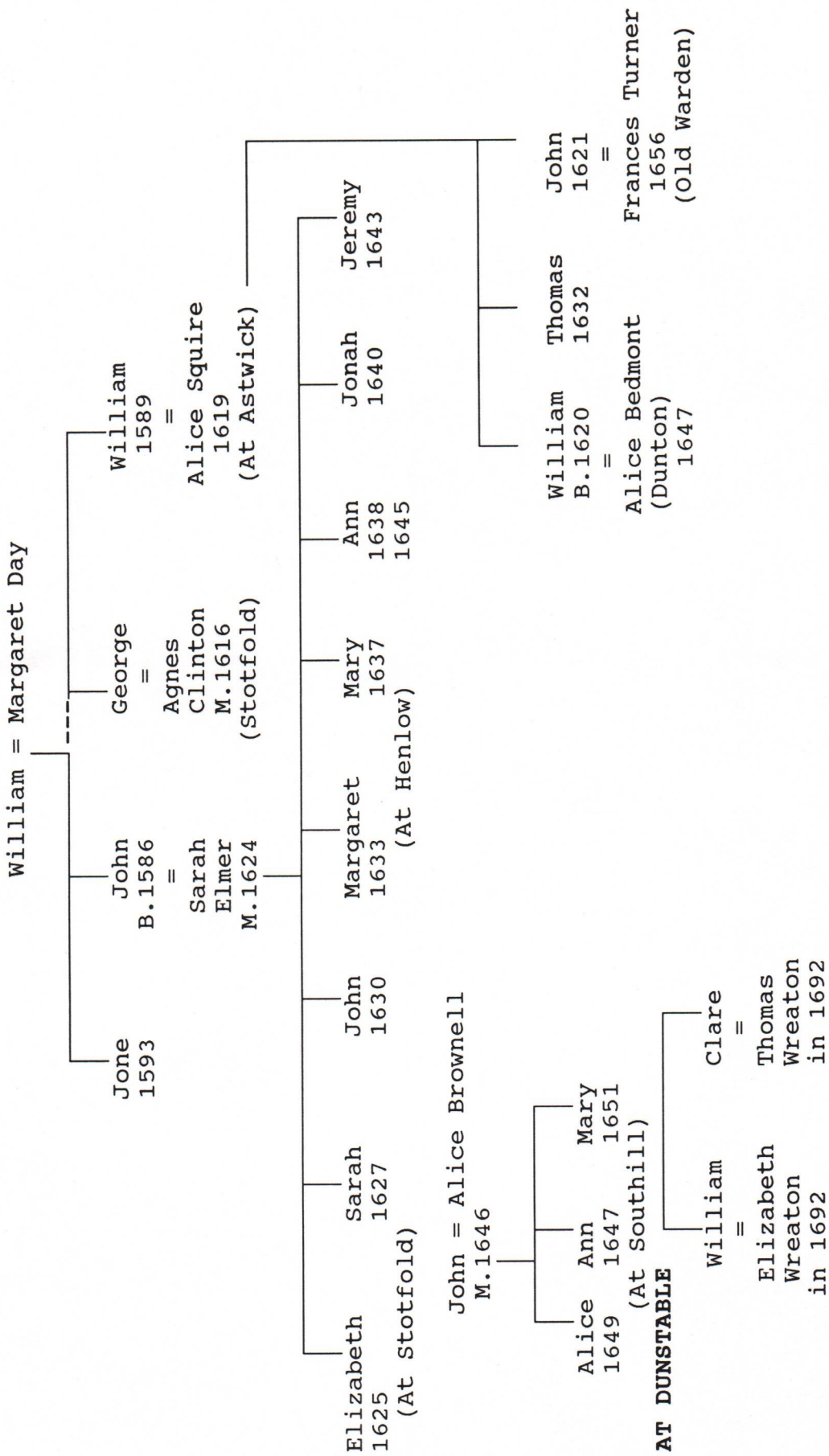

**BRIDFORD DEVON.**

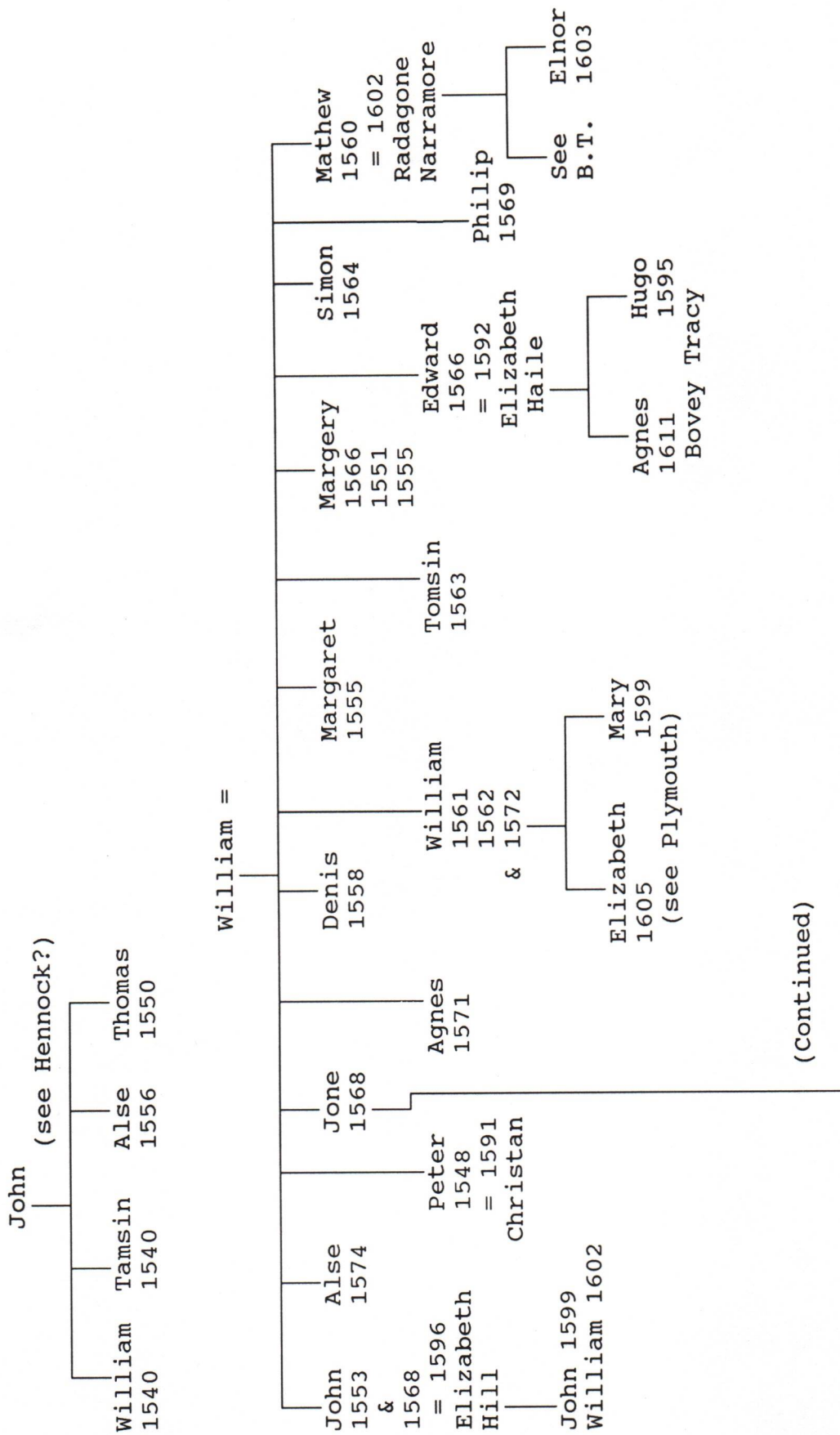

(Continued)

**BRIDFORD Devon**  
(Continued)

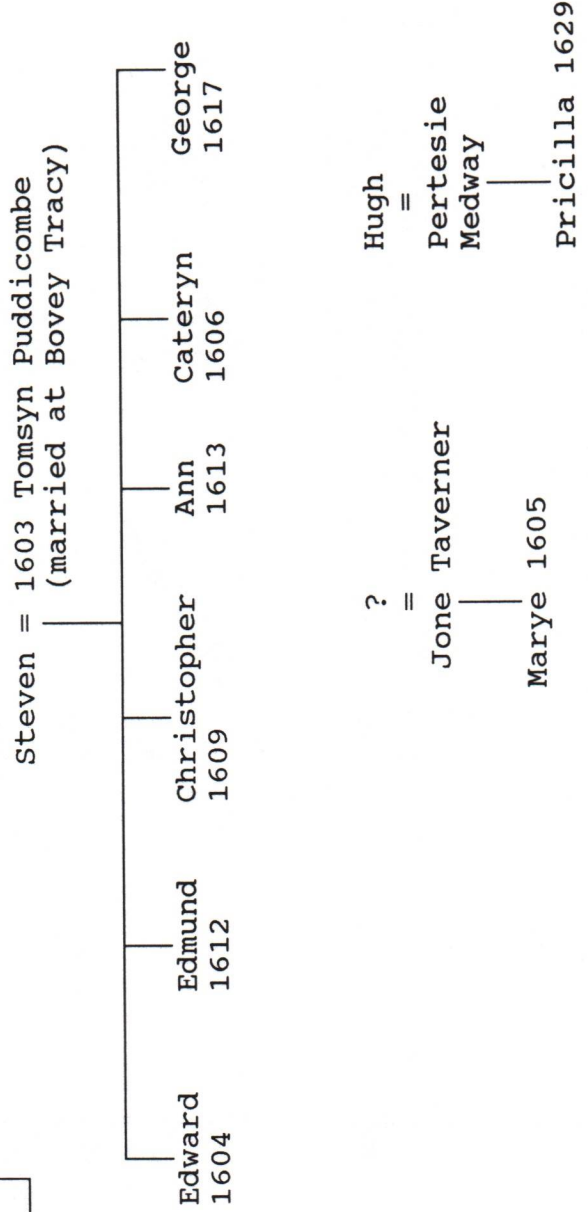

- Jane Taverner = Richard Langworthie 1592
- John Taverner = Elizabeth Zentle 1611
- John Taverner = Isett Langanden 1622
- Peter Taverner = Elizabeth Staplehill 1619





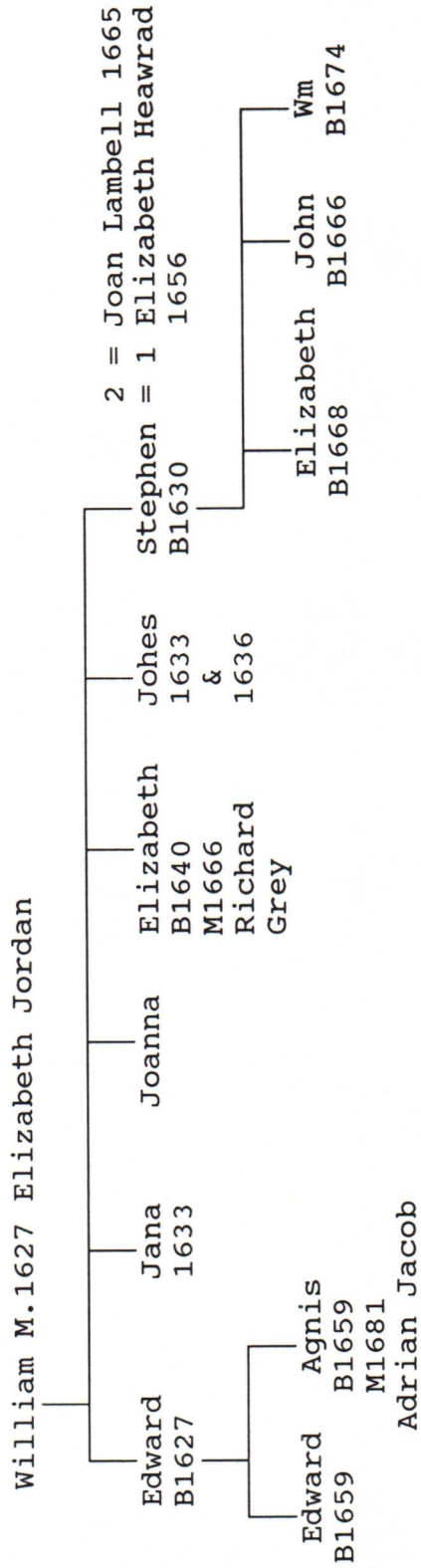
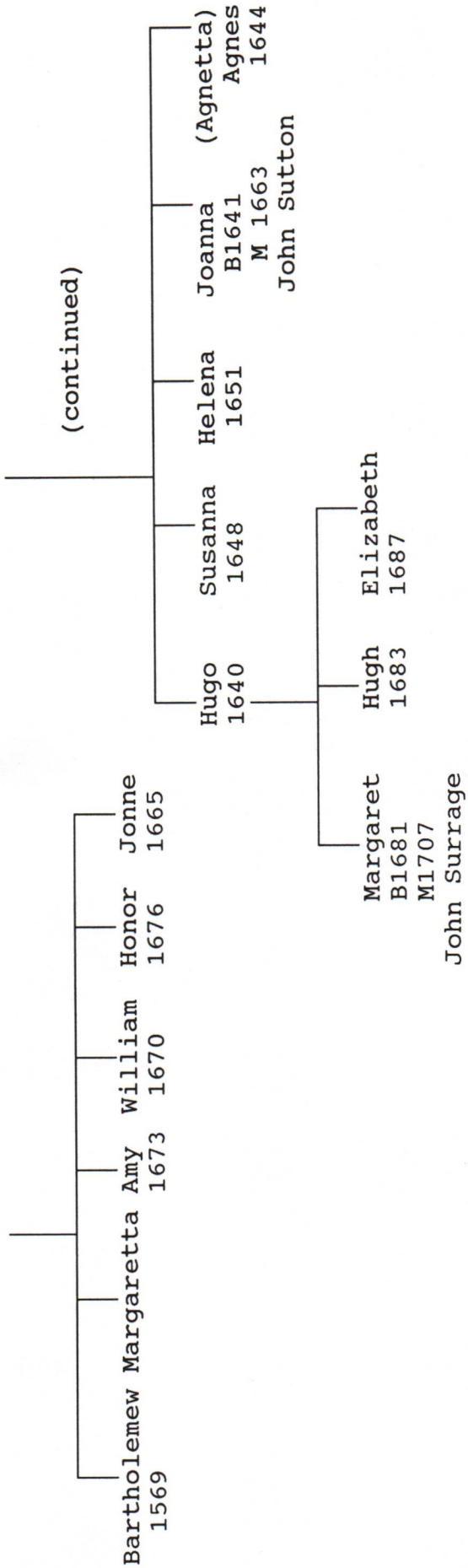

(Continued)

(Continued)

Peter M1660 Tomasin Wallish

Peter B1661 Married Joan

Peter 1699  
John 1695

(see Chadleigh)

Elizabeth Witrow =

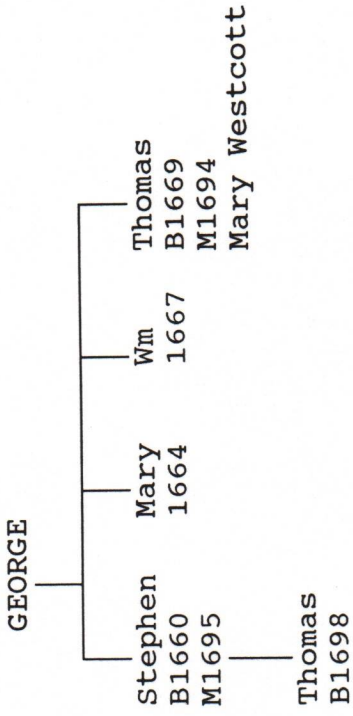

William  
Hugh B1695

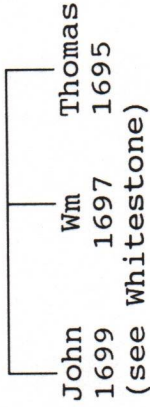

Magdalena Taverner married 1579 John Tappley  
 Redegundis Taverner married 1621 David Ellacombe  
 Elizabeth Taverner married 1646 Alex Sutton  
 Sarah Taverner married 1677 Robert Tayler  
 Joan Taverner married 1693 Sam Floud

John Taverner married Ann Pouttle 1566 Exminster  
 William Taverner christened John Taverner 1572 Exminster  
 John Taverner married Blanche 1581 Exminster  
 John Taverner married Margaret 1596 Exminster  
 John Taverner christened 1560 Paignton  
 Margery Taverner married John Horsham 1575 Paignton  
 John born 1548 Hennock  
 Mable of John Taverner 1549 Hennock  
 Joan Taverner married Roger Lucye 1549 Hennock  
 Joan Taverner married John ? 1580 Hennock  
 Stephen Taverner married Jane Balle 1676 Hennock  
 Susan Taverner married Edmund Randell 1563 Charleton  
 Andrew Taverner born of John Taverner 1582 Widecombe In The Moor  
 William Taverner born of John Taverner 1579 Widecombe In The Moor  
 Maud Taverner married Thomas Gillard 1539 Stoke Fleming  
 William Taverner baptised of Edward Taverner 1595 Ilsington  
 Susan Taverner married Hugh Lamshead 1675 Ilsington  
 Wylmott Taverner baptised of John Taverner 1595 Tedburn In The Moor  
 Elizabeth Taverner baptised of Walter Taverner 1597 Dartmouth St Saviour  
 Christian Taverner married John Standon 1618 Mary Tavy  
 Jaone Taverner married John Allen 1624 Mary Tavy  
 William Taverner married Sarah Babacombe 1636 Moreton Hampstead  
 Sophia Taverner married John Manneton 1624 Kenn  
 Elizabeth Taverner baptised William Taverner 1605 Plymouth St Andrews  
 Mary Taverner baptised William Taverner 1599 Plymouth St Andrews  
 Elizabeth Taverner married Abraham Mabbett 1624 Plymouth St Andrews  
 Joan Taverner married George Dix 1611 Plymouth St Andrews  
 Steven Taverner married Elizabeth Heawood 1656 Totnes  
 Joan Taverner married John Turner 1656 Totnes  
 John Taverner = Thomazin Westaway 1643 Stamford Courtney  
 John Taverner = Mary Busell 1670 Dunsford  
 John baptised of John Taverner 1673 Dunsford  
 William baptised of John Taverner 1676 Dunsford  
 Joan baptised of John Taverner 1680 Dunsford  
 John baptised of Thomas Taverner 1691 Dunsford  
 William Taverner married Ann Tozar 1674 Dunsford  
 Jones baptised of Ricks 1646 Oakhampton  
 Henry Taverner married Agnes Powning 1632 Exeter St George  
 Grace Taverner married Ew Lopez 1674 Lustleigh  
 Thomas Taverner married Joan Sellack 1683 Lustleigh  
 Elizabeth Taverner baptised of ? & Ursula Taverner 1634 Ermington  
 Dorothy Taverner married John Cooke 1653 Buckfast Leigh  
 Amey Taverner baptised of John Taverner 1661 Stoke-in-Teignhead  
 John Taverner baptised of John Taverner 1654 Stoke-in-Teignhead  
 Mary Taverner baptised of John Taverner 1645 Stoke-in-Teignhead  
 William Taverner baptised of John Taverner 1648 Stoke-in-Teignhead  
 William Taverner baptised of Mary Taverner 1670 Stoke-in-Teignhead  
 Ann Taverner married Jeffrey Neckels 1687 Stoke-in-Teignhead  
 Philip Taverner married Johan Mudge 1606 Stoke-in-Teignhead

**Chagford**

Dunes = Vignes Bodye 1599  
Amey = Banabe Varder 1618  
Anne = John Vogwell 1639  
Diones = George Hodge 1665  
Grace = William Vallence 1668  
Peter = Barbara Frend 1635  
Richard = Agnes Scott 1673  
Sarah = Thos Sellett 1691  
Thomas = Mary Aynell 1662  
Tomasin = John Steer 1750  
William = Jane Fraye 1673

**Kings Tengnton**

Julian = Ed Grant 1676  
Thomas = Julian Brown 1671

**Plympton St Mary**

Katherine = Richard Coale 1676  
Margaret = Samson Fostard 1610

**Broad Clyst**

Agnes = Thos Pumery 1690

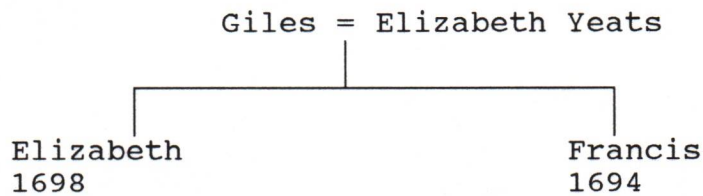

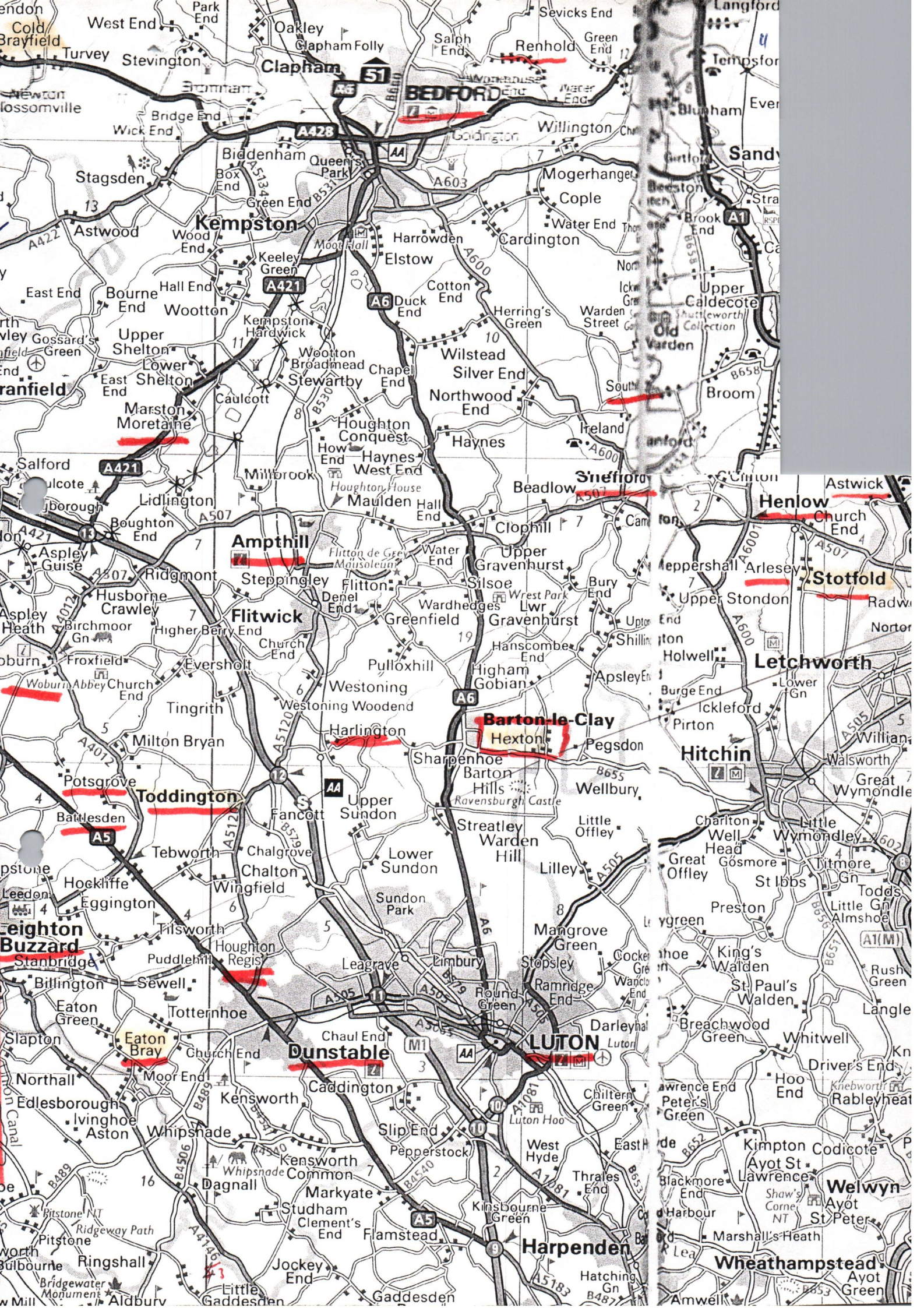

HERTFORDSHIRE

At BRAUGHTON

WYLLIAM  
|  
JOHN 1627

CHESHUNT

JOHN = MARTHA  
|  
JOHN 1684

BROXBORNE

RICHARD  
|  
JOHN 1727

At MUCH HADDON

GEORGE = ALICE 1633

WORMLEY

JOHN = FRANCES  
|  
THOS 1681  
|  
THOMAS 1730  
(Cheshunt)

1628 JOHN = JOAN HARLINGTON

1628 John married Joan Harlington

**LEICESTER**

Sons of Rychard (D.1575) owned land in Leicestershire at Austrey and Polesworth (1545). Next villages are Norton, Twycross, Appleby, Magna, Sibson, Upton, Ratcliffe Culey, Swepston, Heather, Ibstock, Bostworth, Orton-on-the-Hill.

From the I.G.I. of Leicester I have pieced together the following family trees. Please bear in mind these are best guesses and need verification (Dotted Lines). Undoubtedly the families were related, wills would be required to obtain more details of the relationships.

LEICESTER - NORTON JUXTA TWYCROSS

ALICE  
=  
ROBERT  
HARDING  
1638

ELLEN  
=  
THOS  
WINTER  
1638

MICHAEL  
=  
MARIE  
SHOWELL  
1622

THOS  
|  
=  
|  
MARY  
GRUNDYE  
1712

WILLIAM = MARGERY OR MARGARET  
(see Appleby Magna)

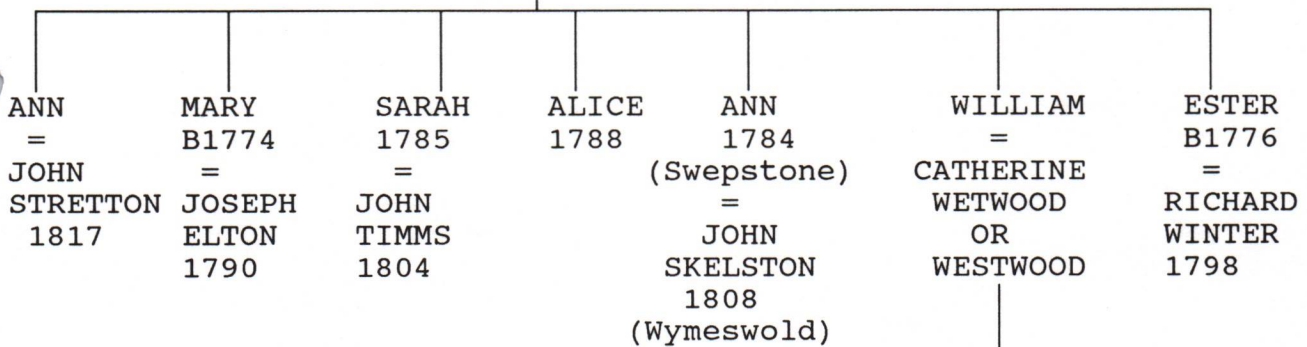

Appleby



SIBSON

JOSEPH = MARY

THOS  
1699

=

ANN BUCKLEY

ANN  
1732

THOS  
1735

=

JANE  
HILL  
(Magt  
Bosworth)

ANN  
1733

=

GEO  
CHAPMAN  
(Upton)

JOHN  
1738

JOSEPH  
1743

=

SARAH  
WILDAY  
1792

SARAH  
1804

NICHOLAS  
1800

ALICE  
1807

JOHN  
1796

JOSEPH  
1793

WILLIAM  
1803

THOMAS  
B. 1795

MICHAEL  
1798

=  
MARY  
VARRAN  
1821

THOMAS  
1821  
& 1828

SARAH  
ANN  
1822

ROSE  
1838

JOSEPH  
1824

ALICIA  
1828

ELLEN  
1830

JOHN  
1827

RICHARD  
1831  
(Higham On The Hill)



LEICESTER - APPLEBY MAGNA

BARTHOLOMEW TAVERNER  
 (probably son of Thos  
 of Kettlestone) *see  
 warrick*

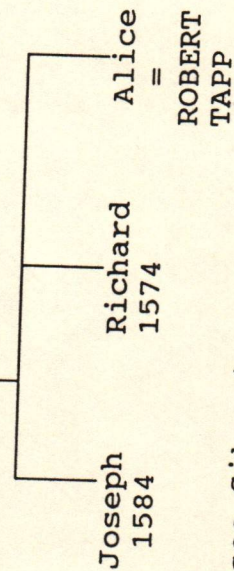

(see Sibson)

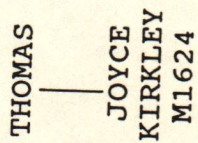
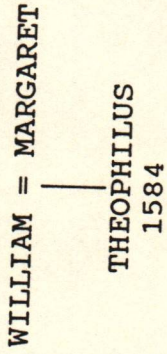

ALICE =  
 Wm FOSTER  
 1688

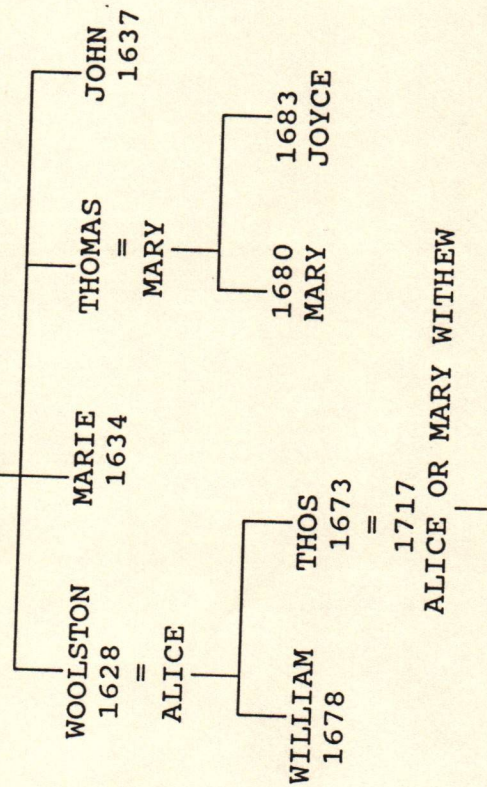

(Continued)

(Continued)

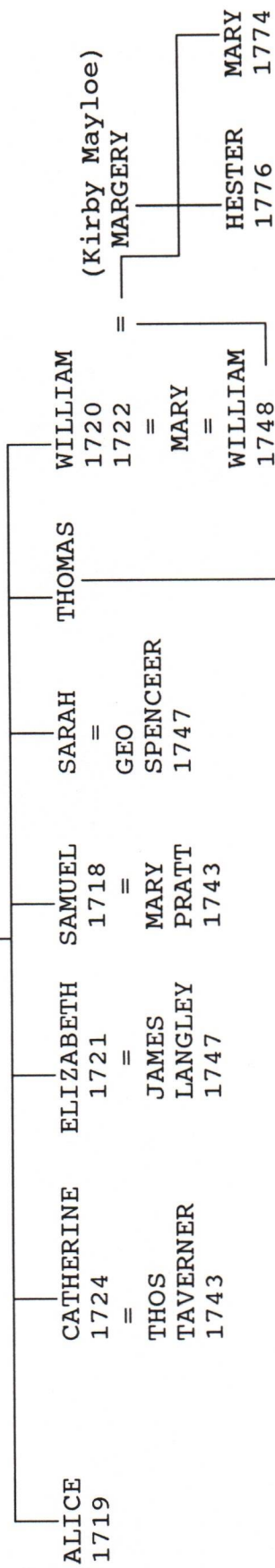

ESTHER NOURSE 1739

(Ashby De La Zouche)

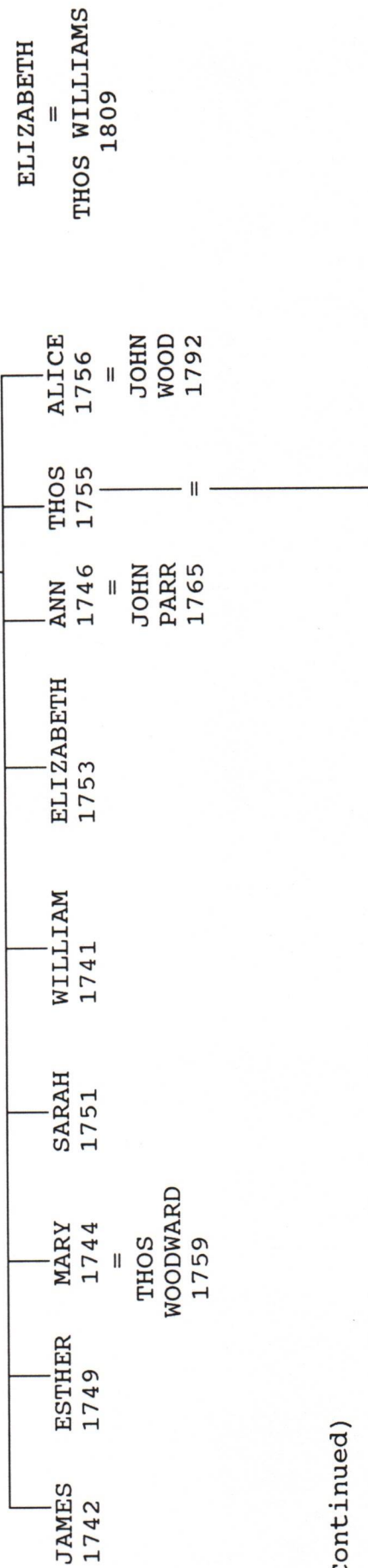

(Continued)

(Continued)

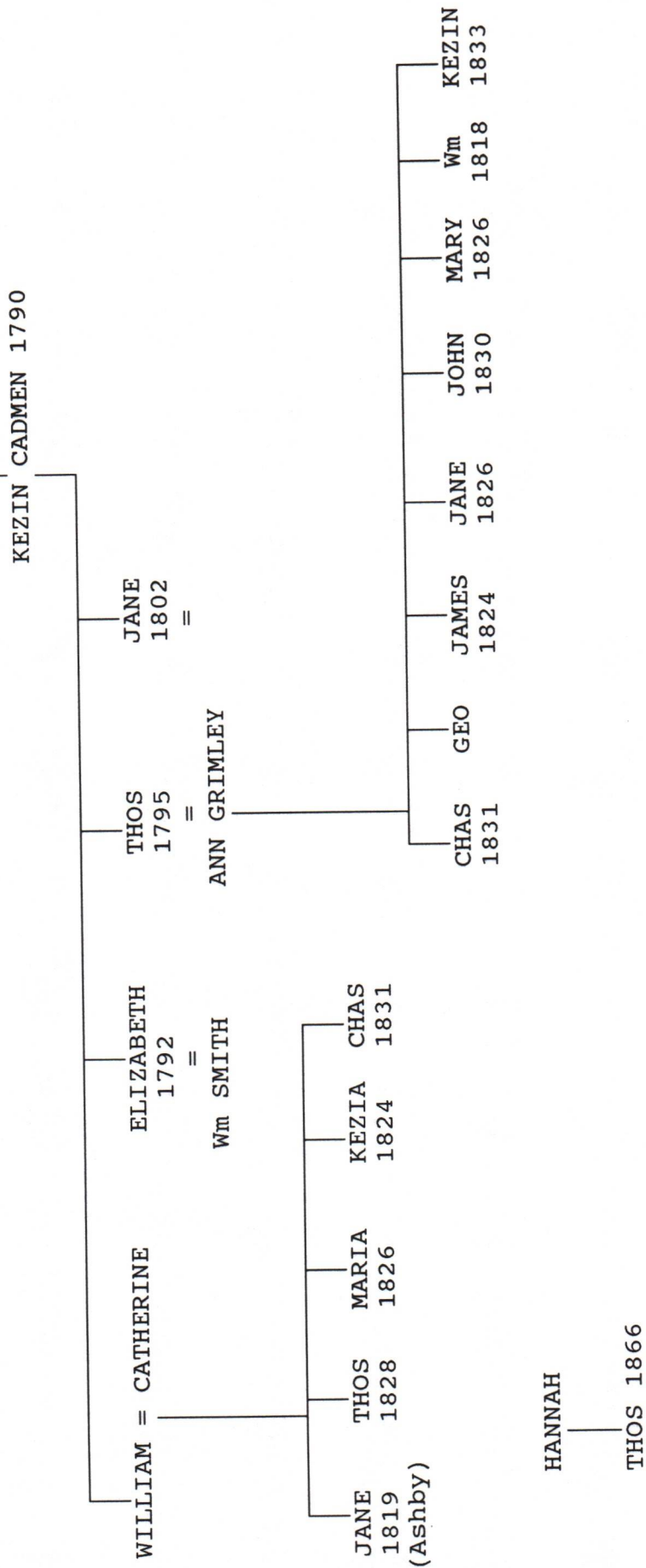



(Continued)

1810 THOS = ELIZABETH  
WRIGHT  
(Ibstock)

HANNAH JOHN  
1810 1815  
(Markfield) (Heather)

THOS =  
ANN  
BUCKLEY  
1730  
(Thornton)

(Coleorton)  
AUGUSTINE / CATHERINE  
=  
ELIZABETH JOHN  
BENTLEY BOULDS  
1744 1733

(Wymeswold)

THOS =  
ANN SEAL  
1800

(Leicester)

ELIZABETH =  
JOHN WEBSTER  
1820

(Stretton-En-Le-Field)

THOS = CATHERINE  
|  
KEZIA 1822

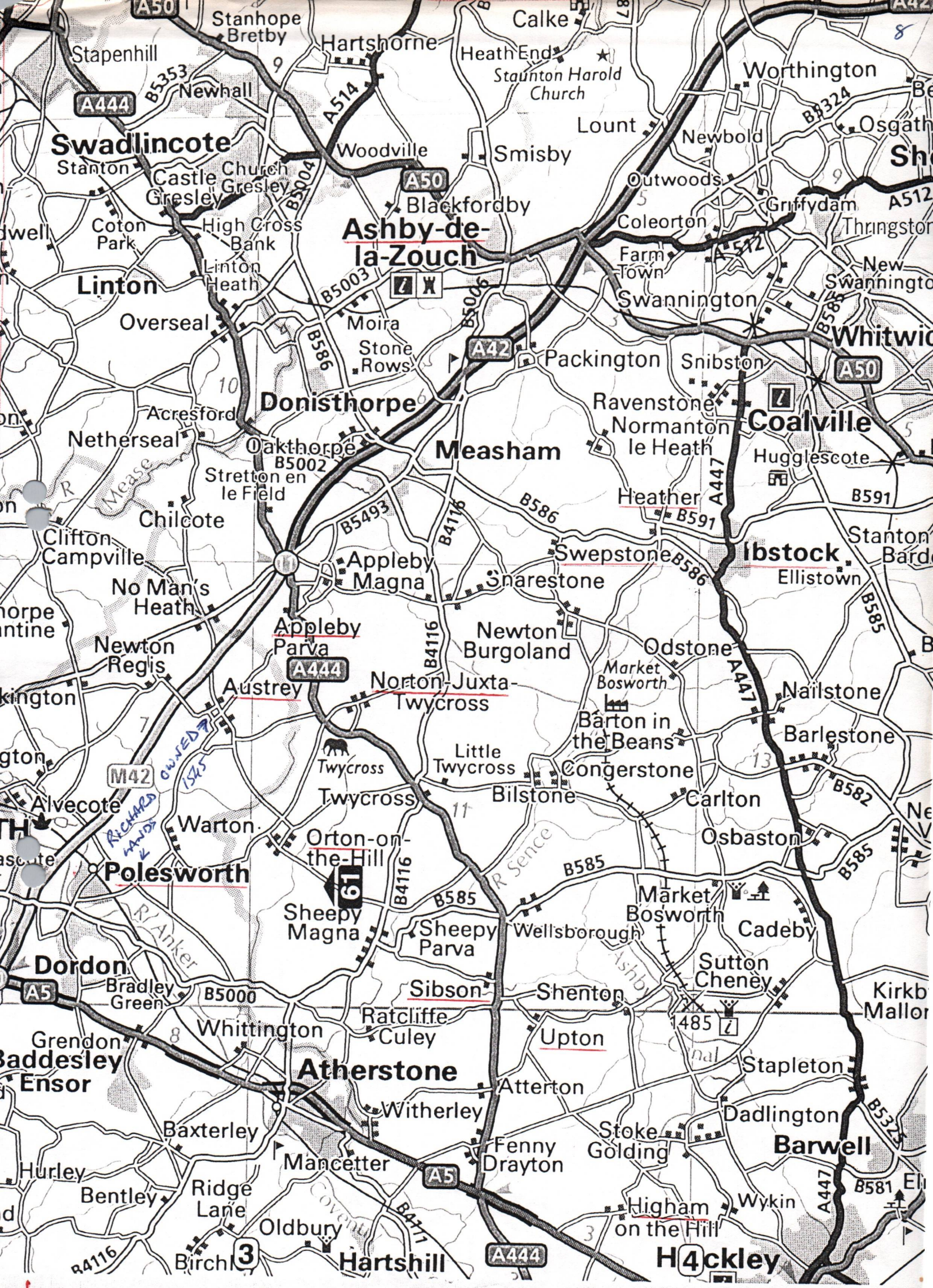

**Ashby-de-la-Zouch**

**Appleby Parva**

**Orton-on-the-Hill**

**Atherstone**

**Coalville**

**Ibstock**

**Barwell**

**H4ckley**

M42

OWSED

RICHARDS

MAIDS

RY Anker

61

A5

A444

10m = 7 1/4"

**LATER NORFOLK TAVERNERS**  
 (See Volume 1 for earlier Norfolk)

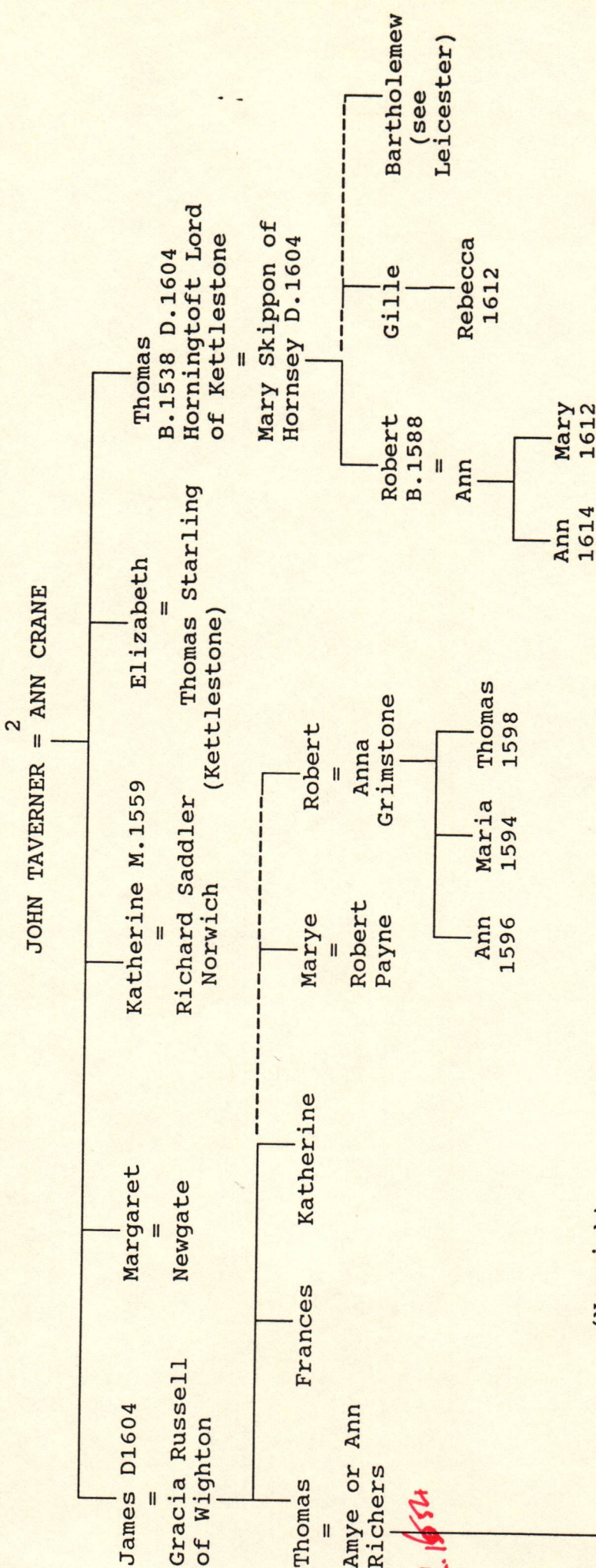

(Norwich)  
 Sebastian = Elizabeth  
 alive in 1666

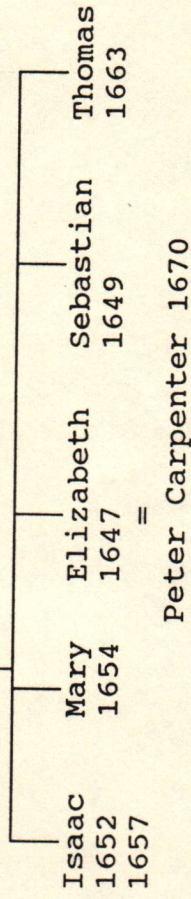

(Continued)

*Taper 2 1618  
 Thorford Norfolk*

*d. 1634*

(Continued)

Norfolk Hearth Tax 1664 a1666  
East Derham Ann Taverner Wid  
Heydon, Francis Taverner  
Kings Lynn Widd Taverner  
Norwich Sarbasten Taverner

*died before 1654.*

alive 1664

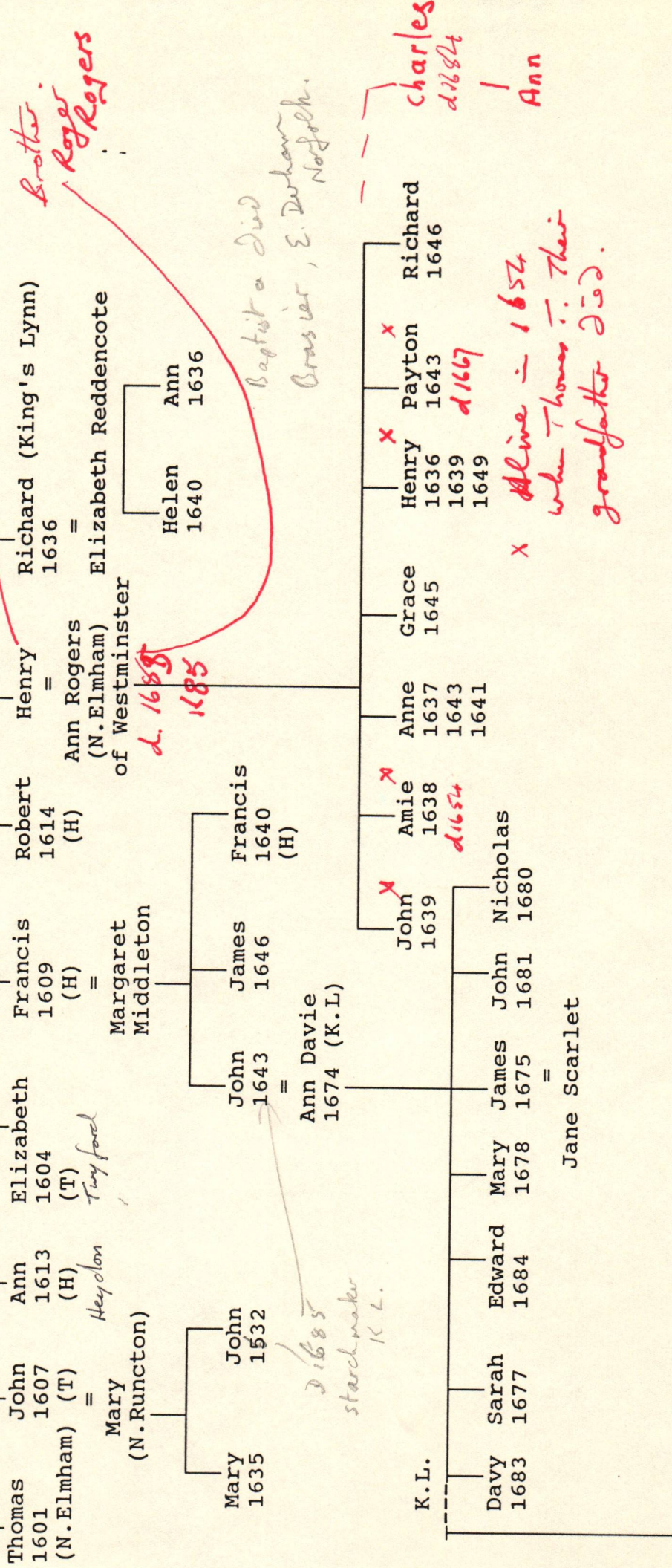



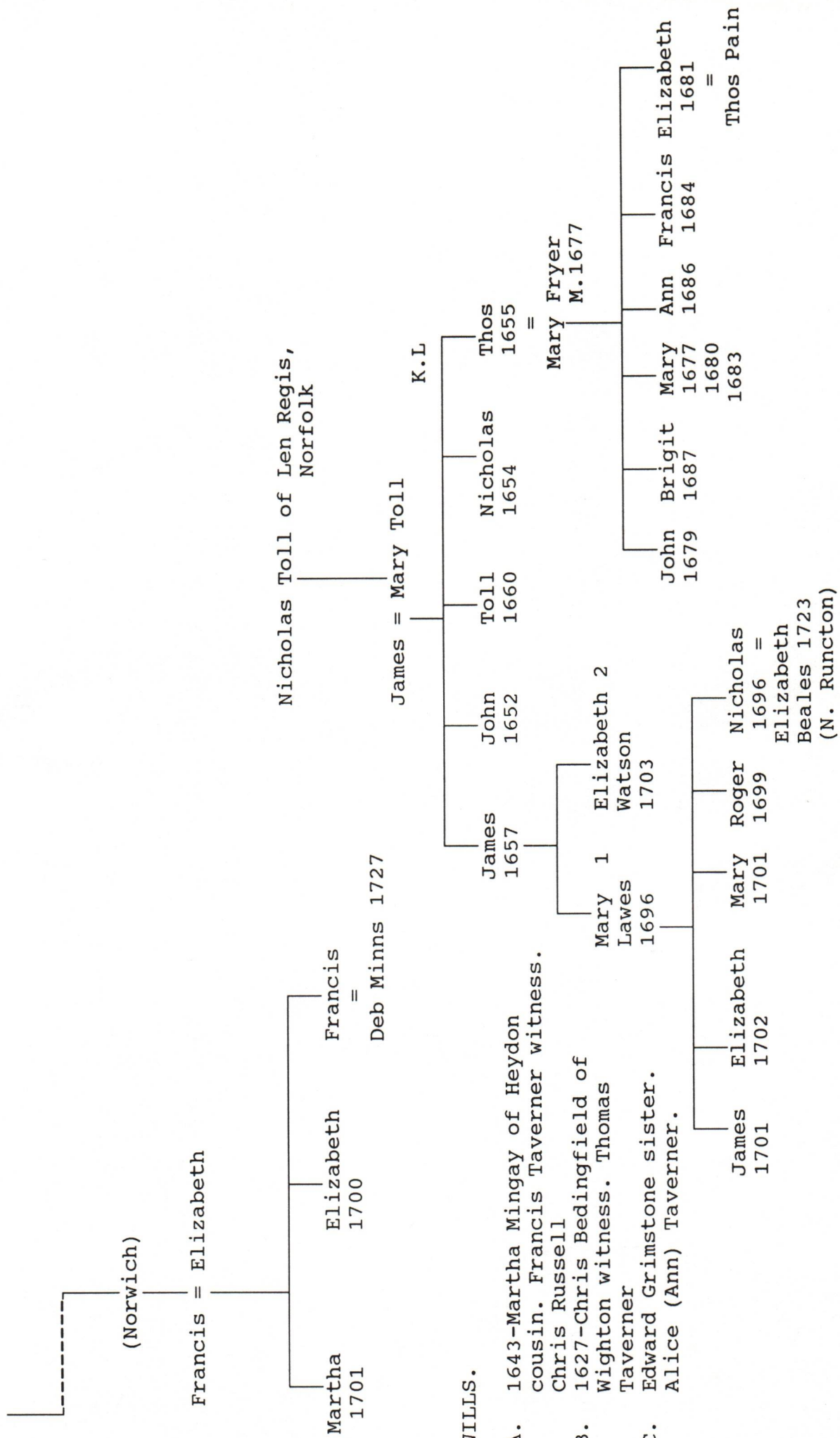

10 MILES

NORFOLK 18



56

## CHAPTER 5

### **The Taverners of London & Middlesex**

This is a daunting task, mainly because it is so fragmented.

One source states that before 1500 about 1 in 8 of the inhabitants of England spent at least some of their lives in London. After 1500 it was around 1 in 6. Folk would drift into London to look for work, come to London to get married at one of the fine churches, or more permanently in the hope of finding fame and fortune. Others would come for their education or to study law and go to court. Gentry would send their daughters to London to find a suitable husband.

So geographical grouping is often only partly helpful.

After long deliberation of how to present this fragmented picture I have decided to show the information in date order. This may be helpful when correlating the information with other counties.

Joyce Taverner married Thomas Julian 1565 Westminster, St Clement Danes.

Robert Taverner married Margery Ryppington 1566 St James, Clerkenwell.

Elizabeth Taverner baptised of James Taverner 1571 Christchurch, Greyfriars.

James Taverner married Elizabeth Cockes 1575 St James, Clerkenwell.

Elizabeth Taverner died 1575 St James, Clerkenwell.

Elizabeth Taverner married James Reade 1578 St Giles, Cripplegate.

Roger Taverner of Upminster died Robert & Richard, Sons 1582 Pcc.

Agnes baptised of .....Taverner 1586 St Lawrence Jewry.

Ellen baptised of .....Taverner 1588 St Mary, Magdalene Milk St.

Marie baptised of .....Taverner 1590 St Mary, Magdalene Milk St.

Margaret Taverner married John Howe 1585 St James, Clerkenwell.

Thomas Taverner baptised of Thomas Taverner 1585 St Michael, Cornhill.

Richard Taverner of Upminster married Elizabeth Barbor 1592 St Andrews by the Wardrobe.

John Taverner baptised of John Taverner 1599 St Giles, Cripplegate.

Dorothy Taverner baptised of Thomas Taverner 1592 All Hallows Bread St.

John Taverner buried of Thos Taverner 1593 at St Pauls.

William Taverner baptised of Thomas Taverner 1590 at St Pauls.

Fowlke Taverner baptised of Thomas Taverner 1589 at St Pauls.

Elizabeth Taverner married Peter Razwell 1601 St Andrew's by the Wardrobe. (widow of Richard of Upminster).

Christian Taverner married Richard Hill 1600 Westminster, St Clement Danes. (see Upminster, Essex).

John Taverner married Ann Thorne 1603 Westminster, St Clements Danes.

Ann Taverner baptised of John & Ann 1604 Westminster, St Clements Danes.

John Taverner baptised of John & Ann 1606 & 1609 Westminster, St Clements Danes.

Mary Taverner baptised of John & Ann 1607 Westminster, St Clements Danes.

George Taverner baptised of John & Ann 1615 Westminster, St Clements Danes.

William Taverner of Stepney died, Estate to Elizabeth 1610 Stepney, Middlesex.

Mary Taverner baptised to John & Margaret 1607 St James, Clerkenwell.  
Francis Taverner married Agnes Dunn 1606 St Mary, Woolworth.  
Francis Taverner baptised of Francis & Agnes 1607 St Christopher le Stocks.  
Ann Taverner baptised of Francis & Agnes 1606 & 1609 St Christopher le Stocks.  
Thomas Taverner baptised of Francis 1618 St Giles, Cripplegate.  
Edward Taverner baptised of Francis 1619 St Giles, Cripplegate.  
Henry Taverner baptised of Francis 1621 St Giles, Cripplegate.  
Hanna Taverner baptised of Francis 1614 St Giles, Cripplegate.  
Francis Taverner baptised of Francis 1629 St Giles, Cripplegate.  
Mary Taverner baptised of John died 1 month 1620 November St James.  
John Taverner baptised of John Taverner 1616 Dec St James, Clerkenwell.  
Wyborrowe Taverner baptised of John Taverner 1615 Dec St James, Clerkenwell.  
John Taverner married Margaret Bouldinge 1615 Dec St James, Clerkenwell.  
Onay Taverner married Peter Alexander 1613 St James, Clerkenwell.  
Roberte Taverner married Ann Godman 1614 St Andrews by the Wardrobe. (of Arnways, Essex).  
Jane Taverner baptised of Ralph Taverner 1615 St Margaret, Westminster.  
John Taverner baptised of Ralph Taverner 1612 St Margaret, Westminster.  
William Taverner baptised of Ralph Taverner 1619 St Margaret, Westminster.  
Ralph Taverner baptised of Ralph Taverner 1621 St Margaret, Westminster.  
Christopher Taverner baptised of Thomas Merchant Tailor 1619, All Hallows Bread Street.  
William Taverner married Joan Hallidaye 1611 St Botolph.  
Audrey Taverner married Ed Measure 1620 St Andrews by the Wardrobe.  
Audrey Taverner married John Banks 1629 St Giles, Cripplegate.  
Walter Taverner baptised of John & Margery 1624 St Augustine, Watling Street.  
Edward Taverner baptised of John & Elizabeth 1625 St Botolph.  
Thomas Taverner baptised of John & Elizabeth 1632 St Botolph.  
Elizabeth Taverner baptised of John & Elizabeth 1628 St Botolph.  
Alice Johnson died Mother in law of Thomas Taverner 1626 All Hallows Bread Street. (see Lambourne).  
Elizabeth Taverner married William Wright 1631 St James, Clerkenwell.  
John Taverner married Alyce Williams 1639 St James, Clerkenwell.  
John Taverner baptised of Richard 1639 St Andrews By The Wardrobe.  
Richard Taverner baptised of Richard 1635 St Andrews By The Wardrobe.  
Thomas Taverner baptised of Edward 1636 St Andrews By The Wardrobe.  
Elizabeth Taverner baptised of Edward 1637 St Andrews By The Wardrobe.  
John Taverner baptised of John & Margaret 1633 White Chapel & Stepney.  
Elizabeth Taverner baptised of William & Katherine 1640 White Chapel & Stepney.  
William Taverner baptised of John & Elenor 1630 St Augustine, Watling Street.  
Cecilie Taverner baptised of John & Elenor 1632 St Augustine, Watling Street.  
Thomas Taverner married Elizabeth Perrin 1634 Tottenham.  
Thomas Taverner married Elizabeth Scarecrowe 1639 All Hallows, London Wall.  
Ann Taverner baptised George & Katherine 1648 St Andrews, Holborn.  
George Taverner baptised George & Katherine 1650 St Andrews Holborn.  
John Taverner married Joane Archer 1642 St Helen, Bishopgate.  
John Taverner married Grace Hartwell 1658 St James, Clerkenwell.  
John Taverner married Mary Metcalf 1659 St James, Clerkenwell.

Amy Taverner baptised of John & Amy 1657 St James, Clerkenwell.  
 Elizabeth Taverner baptised of Henry & Mary 1650 St Giles, Criplegate.  
 Ann Taverner baptised of Henry & Mary 1655 St Giles, Criplegate.  
 Francis Taverner baptised of Henry & Mary 1653 St Giles, Criplegate.  
 Henry Taverner baptised of Henry & Mary 1657 St Giles, Criplegate.  
 Edward Taverner married Rodah Webb 1654 St Giles, Criplegate.  
 Rodah Taverner baptised of Edward & Rodah 1654 & 1657 St Giles, Criplegate.  
 Ann Taverner baptised of Edward & Rodah 1654 St Giles, Criplegate.  
 John Taverner baptised of Edward & Rodah 1656 St Giles, Criplegate.  
 Prudence Taverner baptised of Edward & Jane 1663 St Giles, Criplegate.  
 Elizabeth Taverner baptised Edward & Jane 1665 St Giles, Criplegate.  
 John Taverner married Elizabeth Ball 1658 All Hallows, London Wall.  
 Edward Taverner married Ann Bryan 1652 St Botolph, London.  
 Thos Taverner baptised of Thomas & Elizabeth 1660 St Botolph, London.  
 John Taverner baptised of Thomas & Elizabeth 1655 St Botolph, London.  
 Elizabeth Taverner daughter of John & Mary 1661 St James, Clerkenwell.  
 Thomas Taverner married Elinor Cumpden 1668 St James, Clerkenwell.  
 Martha Taverner married Steven Randall 1677 St James, Clerkenwell.  
 Edeth Taverner married Timothy Butler 1667 St James, Clerkenwell.  
 John Taverner baptised of Richard & Margaret 1664 St Bride Fleet Street.  
 Edward Taverner married Ann Whitaker 1666 St George, Hanover Square.  
 Richard Taverner baptised of Rob & Elizabeth 1670 & 1682 St Sepulchre.  
 Robert Taverner baptised of Rob & Elizabeth 1672 St Sepulchre.  
 Thomas Taverner baptised of Thos & Elizabeth 1671 St Gregory By St Paul.  
 Elizabeth Taverner baptised of Thos & Elizabeth 1676 St Augustine, Watling Street.  
 Richard Taverner baptised of Thos & Elizabeth 1677 St Augustine, Watling Street.  
 Thomas Taverner married Elizabeth Pendleton 1670 St Botolph.  
 John Taverner married Jane Satterthwait 1675 St Botolph.  
 Sarah Taverner baptised of Samuel & Jane 1680 St Giles, Criplegate.  
 John Taverner married Elizabeht Sharrock 1686 St James, Dukes Place.  
 Richard Taverner baptised of Richard & Elizabeth 1698 St Bride, Fleet Street.  
 John Taverner married Margaret Randall 1690 St James, Dukes Place.  
 John Taverner baptised of Michael & Mary 1694 St Sepluchre.  
 Elizabeth Taverner baptised of Robert & Elizabeth 1698 St Sepluchre.  
 William Taverner baptised of Robert & Elizabeth 1700 St Sepluchre.  
 Edmund Taverner baptised of Robert & Elizabeth 1705 St Sepluchre.  
 Robert Taverner married Elizabeth Tulley 1697 Spitalfields, Stepney.  
 William Taverner married Rebecca Corbin 1699 St Katherine By The Tower.  
 William Taverner baptised of William & Alatheia 1703 St Martin, Ludgate.  
 Cordelia Taverner baptised of William & Alatheia 1702 St Martin, Ludgate.

1545. Land in Austrey & Polesworth  
owned by Richard, Robert & Silvester  
Taverner.

Speculation :-

Richard, Robert & Silvester did not  
own land in Austrey & Polesworth by accident

Either it was inherited from a relation  
or they bought the land to help a  
relation.

Their father John had ~~two~~<sup>a</sup>  
brothers Thomas and Henry. Robert  
John's father, Nicholas  
had two brothers Henry & Thomas

Bartholomew Taverner who died in  
Austrey in 1551 had 3 sons

Thomas, Henry & Robert.

It therefore seems quite possible  
that one of the Taverners of North Elms  
settled in Austrey some time before  
1545.

1551

Will of Bartholomew Taverner of  
Austrey, Warwick

Bartholomew Taverner = Agnes

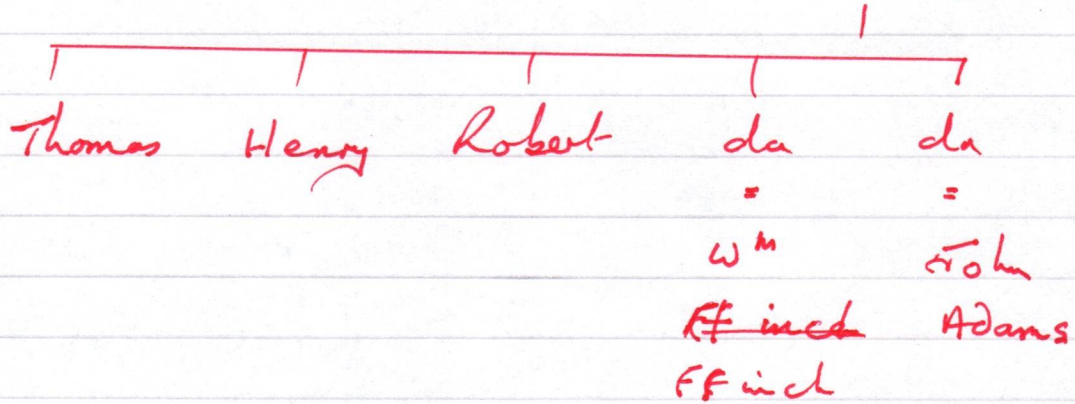

Witnesses Roger Taylor  
Thomas Taverner  
Thomas Farmer.

Also see Leicestershire.

LITCHFIELD WILLS

1562

WINIFRED T.

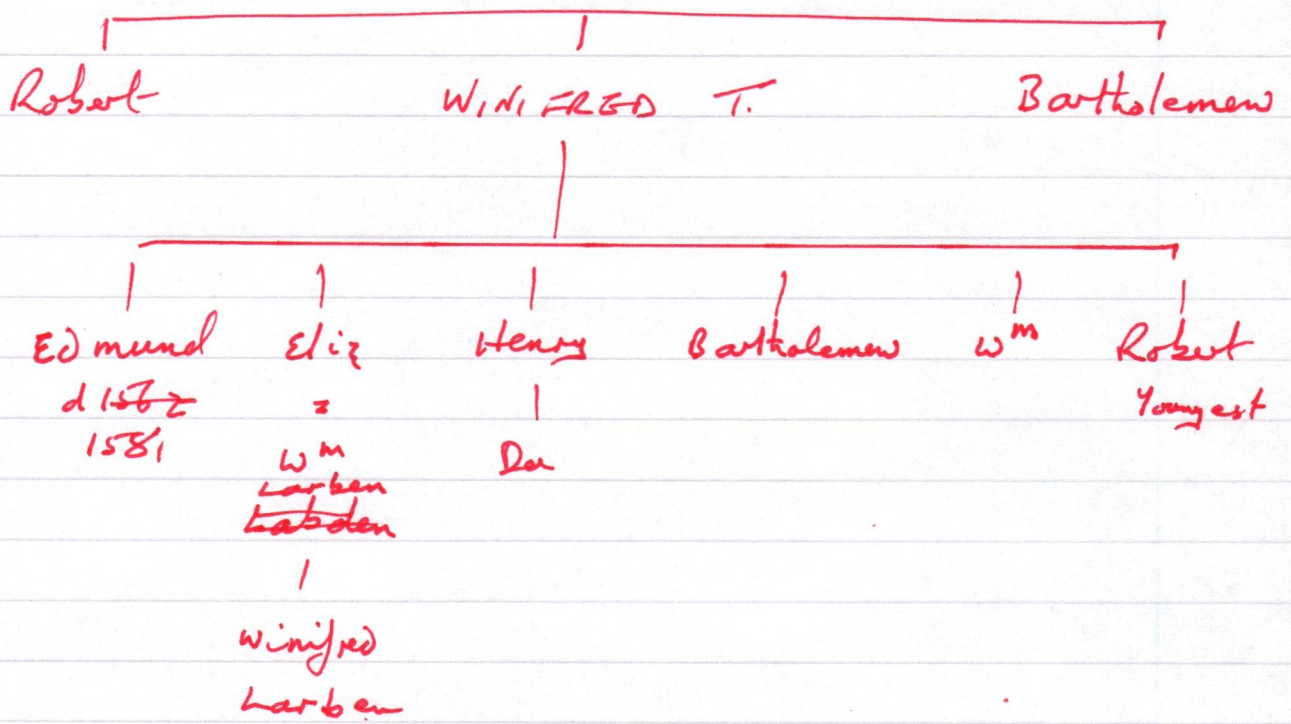

Witness

John Hull

Wm Fawcse

George Laben

Thos Outon

W Laben



1581 Edmund T. of Polesworth, Husbandman  
(wifred.)

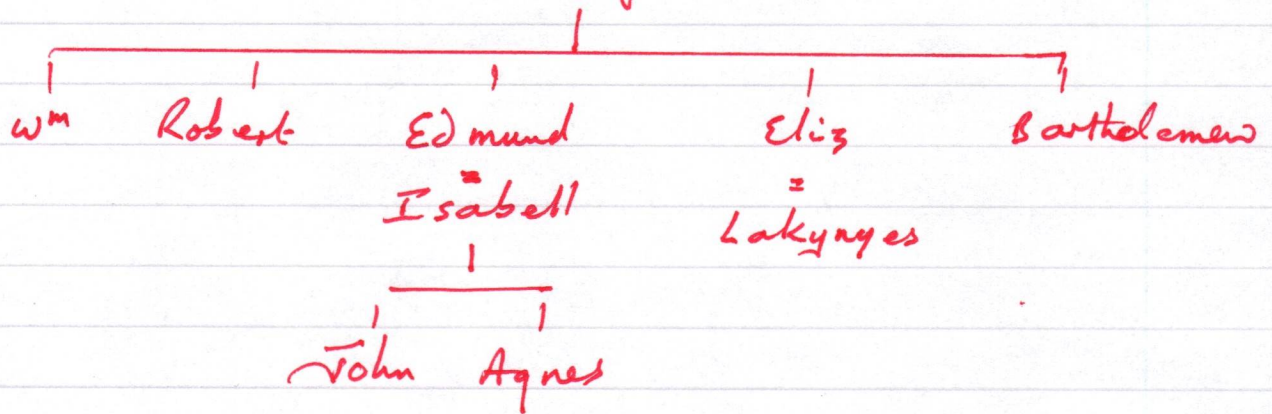

Witness.

Isabella Taverner  
Richard Bromley  
Nicholas ?

## Warwick

### Austrays n

- ✓ 1587 Agnes = William Chettle.
- ✓ 1571 Eliz = Michael Walker
- ✓ 1600 Henry = Agnes Hall
- ✓ 1648 Katherine = William Heefield.
- ✓ 1595 Margery = John Fielding
- ✓ 1566 Robert of Robert Taverner & Ann
- ✓ 1577 Thomas m Margaret Eedes

## Newton Regis

166) Katherine m Tho Spenser

warwick.

Polesworth

- / 1682 Ann da of Thomas Taverner
- / 1677 Dorothy "
- / 1684 Elizabeth da of John Taverner
- / 1662 Elnor m. Richard Daxter
- / 1622 Anne of John Taverner
- / 1689 John of John
- / 1672 Mary m Richard Hull
- / 1697 Mary of Samuel Taverner
- / 1697 Samuel of Samuel Ann Smith
- / 1645 or 1685 Thomas of John (child)
- / 1691 Thomas of John
- / 1694 Thomas of Samuel

sheldon studley

1683 Forster, son of Rachel Taverner.

TAMWORTH

1581 John m Elnor Elnor Orton  
1663 Josephus of Benjamin T.

Warwick  
Kingsbury.

- 1585 Ann da of John  
1597  
1654 Hannah of John & Elizabeth Tavernor  
1587 Isabel of John Tavernor  
1591 Isabel Tavernor  
1625 Isabel m John Hancock  
1583 Jane of John  
1609 Jane m Robert Heath  
1653 John of John & Eliz  
1613 Joyce m Humphrey George  
1650 Mary of John & Eliz.  
1657 Persis of "  
1594 Tho of John T.

?

Hannah m Francis Neason 1628

1610 Henry of John Tavernor/sawal  
Dorset and Hardesley

## Warwick

### Coleshill

- 1624 Anne da of Raph Taverne
- 1618 Benjamin of Raph T.
- 1642 Helena of Johannis Taverne / Elizabeth
- 1616 Joh of Raph
- 1644 Radulphus Johannis Taverne / Annae
- 1620 Willia of Raph

### Lea Marston

- 1649 Ann married Thomas Watman (or Wetham)

Silvester T. 2 Joyce? 2 1565.  
 1522 - 1564 sept 22  
 Silvester, Ely Camb.  
 to Relict Tocosa T. 2  
 2 Thos Tulcan R  
 st Clement Dames

Silvester T. 1  
 1550 - 1621  
 Thomas of Kent  
 B 1552  
 John  
 ? 1554  
 Richard  
 P 1556  
 = 1588  
 Mgt Clark

st Mary Mag. MILKET  
 b 1588  
 Elizer Ellen Lucy  
 m  
 1608  
 Thos  
 Phage  
 summit  
 h 1590  
 Mary  
 m  
 1610  
 Thos  
 Wythers  
 20 July  
 b 1586  
 at st hawrence  
 Ann  
 or  
 Agnes  
 1610  
 2  
 Richard  
 Bigg  
 Tho, mentioned  
 = silvester T's  
 will  
 Susan  
 1591  
 st olave  
 Hart st  
 Henry 1602  
 = d 1660  
 martha Agbarron  
 29/11/1630 =  
 London.

There is at ST Alphage church.

1589  
 Frances  
 st Stephen  
 Coleman st.

1609 m  
 Eliz Pack  
 To Henham

127. E. - - - - - St Leonard Newbury  
 126 E. - 1/2 mile W Str. - - - - - St Leonard Jones  
 126 D. - 1/4 N Str. - - - - - St Leonard S. Jones  
 127. A. - - - - - St Mary Mary. N. St.  
 127 J. - - - - - St Michael Cornhill

126M ? St

St Mary, Wood work

St Clin Topher & stocks

St Andrew by the water

St Margaret, Westminster

All Hallows Bread St.

All Hallows London Wall

St Andrew Holborn

St Helen, Bishopsgate

126 S

127 E

127 B

126 B 1/2 mile NW st. A.

127 S

All Hallows, London Wall

St James Clerkwell

St George Hanover □

St Gregory by St Paul

St Augustin Watling St

St Andrew { Atlegate  
Bishopsgate

St Silas Cripplegate 65N

St Bride Fleet St

St Thomas Dukes Place

St Sepulchre

St Pauls Steyne

St Katharine by the Tower

St Martin, Ludgate

127-13

127. J

126 H 1/10 E. st. P.

127 H

127 C 2x St Andrew { Atlegate  
Bishopsgate

127 A - - - - - St Silas Cripplegate 65N

126 G 1/4 W st. P. - - - - - St Bride Fleet St

127 - - - - - St Thomas Dukes Place

126 C 1/4 N.W. st. P. - - - - - St Sepulchre

127 G - - - - - St Pauls Steyne

126 G 1/8 W st. P. - - - - - St Martin, Ludgate



Jenny's Taverner m (1564) Joane Good man 126 H -

- ① Joyce T m <sup>13/9</sup> (1565) Thos Tuliam 126 E - Widow of Silvester's  
Hughte T m (1566)
- ② James T da (1571) Eliz 126 D  
Judethe T m (1579) Anthony Gates 126 E
- ③ Richard T m (1592) Eliz Barber 126 G of upminster  
of upminster d 1595
- Elij T m <sup>17/2</sup> (1601) Peter Keywell 126 G of up  
Margaret T m 2/2/1581 Richard Rushall 126 A
- ④ Thomas T son (1593) John Swind 126 H ? son of Silvester  
" son 1590 William 126 H  
" paternal son 1589 Fowlke 126 H
- ⑤ Christian T m <sup>8/4/</sup> (1600) Richard Hill 126 E da of upminster  
of up. st. Clement Dames
- ⑥ John T m (1603) Ann Thorne 126 E ? son of Silvester  
da 1604 Ann st. Clem. Dames  
son 1606 Joh westminster  
1609  
da 1607 Mary  
son 1615 George  
Margaret T m w<sup>m</sup> Jones 1606 st. L. Poultony.
- ⑦ Robt T. m (1614) Ann Godman 126 B f Arways  
(Arways)
- ⑧ Francis m (1606) Agnes Dunn 126 m ?  
son Francis 1607  
da Ann 1606 or 1609 st. christophle le stock
- ⑨ John & Margery son (1624) Walter 126 H

Robt T<sup>m</sup> (1566) Mgt Hyppington 127J st James Clokerwell  
 Mgt Tavern<sup>m</sup> (1585) John Howe 127J 1/4 mile S.E. st paul.

James T<sup>m</sup> (1575) Eliz Cokes 127J

Eliz T<sup>m</sup> (1578) James Reade 127A.  
 Richard T da 1589 Frances 127A  
 - Taverner da (1586) Agnes 127E } st Lawrence Tavern 1/4 E st p  
 - da 7/4 1588 ELLEN 127A } silvester T. Jr?  
 - 1590 MARIE 127A } st Giles Criplegate 1/2 NE st p

John Tavern<sup>m</sup> son 1599 John 127A Son of silvester.

Thomas T son (1585) Thomas 127J }  
 - son (1592) Dorothy 127A } son of silvester

John T & Margaret da (1607) mary 127J

John T<sup>m</sup> (1615) Mgt Building 127J

John T son (1616 & 1620) Joh 127J  
 John T son 1615 Wyborrowe 127J  
 Thomas T son 1616 christopher 127E All Hallows Bread St.  
 Alice Johnson (Mother-in-law) died 127E ~ 1626 or g. son of silvester  
 merchant Tailor from Hamborone

Francis T son (1618) Thomas 127A SE Giles, Criplegate.  
 24/8 (1619) Edward 127A  
 (1621) Henry 127A  
 (1629) Francis 127A  
 (1614) Hanna 127A.

Onay T<sup>m</sup> (1613) Peter Alexander 127J

William T<sup>m</sup> (1611) Joan Halliday 127.

Audrey T<sup>m</sup> 1620 Ed. Measwe 127B  
 1621 Joh Banks 127A

John T & Eliz. son (1625) Edward 127  
 1623 Thos. 127  
 1628 Eliz 127

Elis T<sup>m</sup> 1631 W<sup>m</sup> Wright 127J